



Uncommon Excellence™

1916 - 2016

**DIXON  
BRASS**



*The Right Connection®*

**2016**

[DIXONVALVE.COM](http://DIXONVALVE.COM)

**GOODYEAR**  
GOODYEARBELTING.COM

**Call Toll Free: 1-866-711-4673  
International: +1-727-342-5086**

**We Ship  
World Wide**

# Index

SERIES NUMBER	PAGE
<b>STANDARD HOSE FITTINGS</b>	
102	Male Pipe..... 2
102-SS	Male Pipe-Stainless..... 2
102-BSPT	Male Pipe-British Thread ..... 2
103	Male Pipe Swivel ..... 3
104	Female Pipe..... 3
104-SS	Female Pipe-Stainless Steel..... 3
105	Female Pipe Swivel ..... 4
124	Female Swivel-Ball Seat..... 4
126	Female Swivel-Gasket Seat ..... 4
129	90° Elbow, Male Pipe..... 5
129-SS	90° Elbow, Male Pipe-Stainless Steel..... 5
134	90° Elbow, Female Pipe ..... 5
139	45° Elbow, Male Pipe..... 6
142	Male 45° SAE ..... 6
143	Female Swivel 45° SAE/37° JIC Dual Angle Seat..... 6
144	Female Swivel 45° SAE..... 7
145	Female Swivel 37° JIC ..... 7
177	90° Elbow Splicer ..... 7
177-SS	90° Elbow Splicer-Stainless Steel ..... 8
178	Hose Splicer ..... 8
178-SS	Hose Splicer-Stainless Steel ..... 8
179	Tee Splicer ..... 9
179-SS	Tee Splicer-Stainless Steel..... 9

<b>WELDING CONNECTORS</b>	
152	Right Hand Thread (Oxygen Line) ..... 10
154	Left Hand Thread (Acetylene Line)..... 10
156	Adapter-Right Hand Thread x NPTF Thread ..... 11
158	Adapter-Left Hand Thread x NPTF Thread ..... 11

<b>BRASS FERRULES &amp; CRIMPING TOOL</b>	
200	Stamped Brass Ferrules ..... 12
200-FC	Ferrule Crimper..... 12

<b>RE-USABLE FITTINGS</b>	
180	Ferrule ..... 14
180-SS	Ferrule-Stainless Steel ..... 14
182	Male Stem..... 14
182-SS	Male Stem-Stainless Steel..... 14
183	Reusable Set- Ferrule and Male Stem ..... 15
183-SS	Reusable Set- Stainless Steel ..... 15
184	Female Swivel Stem ..... 16
185	Reusable Set- Ferrule and Female Swivel Stem ..... 16
186	Reusable Splicer Stem ..... 17

SERIES NUMBER	PAGE
<b>BEADED HOSE FITTINGS</b>	
268B	Male Pipe..... 17

<b>LOK-ON (Push-on Style) HOSE FITTINGS</b>	
270-AT	Assembly Tool..... 18
271	Male Pipe Swivel ..... 18
272	Male Pipe..... 19
272W	Yellow Lok-on Cap ..... 19
272-SS	Male Pipe-Stainless Steel..... 19
273	90° Elbow, Male Pipe..... 20
274	Female Pipe..... 20
572	Male GH Thread ..... 21
574	Female GH Thread ..... 21
575	Garden Hose Set..... 21
278	Female Swivel-Ball Seat..... 22
280	Female Swivel-Gasket Seat ..... 22
282	Male 45° SAE ..... 22
284	Female Swivel 45° SAE..... 23
286	Male 37° JIC ..... 23
287	Female Swivel 45° SAE/37° JIC Dual Angle Seat..... 23
287-SS	Female Swivel 45° SAE/37° JIC Dual Angle Seat-Stainless Steel ..... 23
288	Female Swivel 37° JIC ..... 24
288-SS	Female Swivel 37° JIC-Stainless Steel ..... 24
289	Female Swivel 90° Elbow ..... 24
290	Male Swivel SAE Inverted Flare ..... 24
292	Female SAE Inverted Flare ..... 25
294	Rigid Tube Shank ..... 25
294-SS	Rigid Tube Shank - Stainless Steel ..... 25
296	Hose Splicer ..... 25
296-SS	Hose Splicer-Stainless Steel ..... 25

<b>BRASS PIPE FITTINGS</b>	
163	Hex Head Plug..... 26
165	Close Pipe Nipple ..... 26
166	Long Pipe Nipple ..... 26-27
169	90° Male Pipe Elbows..... 27
172	Male Union-NPSM x NPTF..... 27
174	Adapter-Male NPSM x Female NPTF..... 27
176	Male Union-NPSM ..... 28
207-BH	Bulkhead Anchor Coupling ..... 28
211	Square Head Plug - Low Lead..... 28
213	Pipe Cap ..... 29
219	Hex Socket Plug - Low Lead ..... 29
228	Female Cross ..... 29
302	90° Female Elbow ..... 30
304	90° Street Elbow ..... 30
306	45° Street Elbow ..... 30
322	Female Tee ..... 31
324	Male Branch Tee..... 31
326	Street Tee ..... 31
370	Male Hex Nipple ..... 32
371	Female Hex Coupling ..... 32
373	Reducer Bushing ..... 32
375	Adapter-Female x Male ..... 33
377	Reducing Coupler Double Female ..... 33

# Index

SERIES NUMBER	PAGE
<b>GARDEN HOSE FITTINGS</b>	
<b>500</b>	Garden Hose Accessory Products..... 34
<b>501</b>	Female Hose x Female Pipe, non-swivel ..... 35
<b>501-SS</b>	Female Hose x Female Pipe, non-swivel Stainless Steel..... 35
<b>502</b>	Female Hose x Female Pipe, swivel..... 35
<b>502-SS</b>	Female Hose x Female Pipe, swivel Stainless Steel..... 35
<b>503</b>	Female Hose x Male Pipe, non-swivel..... 35
<b>503-SS</b>	Female Hose x Male Pipe, non-swivel Stainless Steel..... 35
<b>504</b>	Female Hose x Male Pipe, swivel..... 35
<b>504-SS</b>	Female Hose x Male Pipe, swivel Stainless Steel..... 35
<b>506</b>	Female Hose x Female Hose, swivel ..... 36
<b>507</b>	Male Hose x Female Pipe..... 36
<b>507-SS</b>	Male Hose x Female Pipe - Stainless Steel..... 36
<b>508</b>	Male Hose x Male Pipe..... 36
<b>508-SS</b>	Male Hose x Male Pipe - Stainless Steel..... 36
<b>509</b>	Male Hose x Male Hose..... 36
<b>509-SS</b>	Male Hose x Male Hose - Stainless Steel..... 36
<b>513</b>	Hose Cap..... 37
<b>514</b>	Male Hose x Male Pipe x Female Pipe..... 37
<b>514-SS</b>	Male Hose x Male Pipe x Female Pipe - Stainless Steel..... 37
<b>578</b>	Garden Hose Mender ..... 37
<b>585</b>	Short Shank Male ..... 37
<b>586</b>	Short Shank Female Swivel, round nut ..... 38
<b>587</b>	Short Shank Set (male and female swivel), round nut..... 38
<b>588</b>	Short Shank Female Swivel, hex nut..... 38
<b>589</b>	Short Shank Set (male and female swivel), hex nut ..... 38
<b>590</b>	Garden Hose Male..... 39
<b>590-SS</b>	Garden Hose Male - Stainless Steel..... 39
<b>591</b>	Garden Hose Female Swivel..... 39
<b>591-SS</b>	Garden Hose Female - Stainless Steel ..... 39
<b>592</b>	Garden Hose Set (male and female swivel) ..... 39
<b>592-SS</b>	Garden Hose Set (male and female swivel) - Stainless Steel..... 39
<b>593</b>	Long Shank Male..... 40
<b>594</b>	Long Shank Female Swivel ..... 40
<b>595</b>	Long Shank Set (male and female swivel) ..... 40
<b>833</b>	Spray Valve..... 41
<b>832</b>	Spray Valve..... 41

<b>GWH</b>	Grease Whip Hose Assemblies, Coupler and Fittings..... 42
<b>GWHZ</b>	Zerk Fittings ..... 42

Because of the health hazards associated with contamination and lead content in drinking water systems, Dixon couplings, unless otherwise specifically approved, are not recommended for potable water service and should not be used in applications where drinking water will contact the wetted surfaces of the couplings.

SERIES NUMBER	PAGE
<b>COMPRESSION FITTINGS</b>	
<b>60C</b>	Sleeve..... 43
<b>60PT</b>	Acetal Sleeve..... 43
<b>61C</b>	Nut ..... 43
<b>61CL</b>	Long Nut ..... 43
<b>62C</b>	Union ..... 44
<b>62CBH</b>	Bulkhead Union ..... 44
<b>63PT</b>	Brass Insert..... 44
<b>66C</b>	Female Connector ..... 45
<b>68C</b>	Male Connector ..... 45
<b>164C/</b>	
<b>264C</b>	Union Tee..... 46
<b>165C</b>	Union Elbow..... 46
<b>169C/</b>	
<b>269C</b>	Male Elbow ..... 47
<b>170C</b>	Female Elbow ..... 47
<b>171C</b>	Male Run Tee..... 47
<b>172C</b>	Male Branch Tee..... 48
<b>176C</b>	Adapter Tee ..... 48
<b>177C</b>	Female Branch Tee..... 48
<b>179C</b>	45° Elbow ..... 48
<b>639C</b>	Seal Plug ..... 49
<b>682C</b>	Straight Thru Tank Fitting..... 49

<b>D.O.T. AIR BRAKE FITTINGS</b>	
<b>60NAB</b>	Sleeve..... 50
<b>61NAB</b>	Nut ..... 51
<b>62NAB</b>	Union ..... 51
<b>62NABH</b>	Bulkhead Union ..... 51
<b>62NBH</b>	Bulkhead Union ..... 51
<b>62NFBH</b>	Bulkhead Union ..... 52
<b>63NAB</b>	Stainless Insert..... 52
<b>64NAB</b>	Union Tee..... 52
<b>65NAB</b>	Union Elbow..... 53
<b>66NBH</b>	Bulkhead Union ..... 53
<b>66NAB</b>	Female Connector ..... 53
<b>68NAB</b>	Male Connector ..... 54
<b>69NAB</b>	Male Elbow ..... 54
<b>70NAB</b>	Female Elbow ..... 55
<b>71NAB</b>	Male Run Tee..... 55
<b>72NAB</b>	Male Branch Tee..... 56
<b>79NAB</b>	45° Elbow ..... 56
<b>NAB</b>	Nylon Tubing..... 50
<b>TC97</b>	Tubing Cutter ..... 50

<b>D.O.T. AIR BRAKE FITTINGS - RUBBER AIR HOSE</b>	
<b>56RBSG</b>	Spring ..... 57
<b>60RB</b>	Sleeve..... 57
<b>61RB</b>	Nut ..... 57
<b>61RBSG</b>	Spring Guard Nut..... 57
<b>67RBSG</b>	Air Brake Hose Nut & Attached Spring ..... 57
<b>68RB</b>	Male Connector Body Only ..... 58
<b>68RBSG</b>	Male Connector with Spring Guard..... 58

<b>LEAD FREE FITTINGS</b>	
<b>LEAD FREE</b>	59-63

NEW

# Standard Hose Fittings

**How to Use  
Dixon Brass  
Standard Hose Fitting  
Part Numbers**

**1020406C**

**1020406C**

**1020406C**

**1020406C**

## SERIES IDENTIFICATION

**HOSE I.D.** (Measured in sixteenths of an inch)

**THREAD SIZE** (Measured in sixteenths of an inch)

**MATERIAL/THREAD TYPE**

Dixon Brass offers over 180 standard hose fittings in 20 different series. All standard hose fittings are intended for use with hose clamps or crimped ferrules.

All standard hose fittings are machined from free cutting brass alloys CDA, 360 and 377 and stainless steel alloys 316, 303 or 304.

102 Series  
360 CDA Brass

102-SS Series  
Type 316 stainless

102-BSPT Series  
British Standard Pipe Thread  
360 CDA Brass

For SS contact Dixon for price and availability

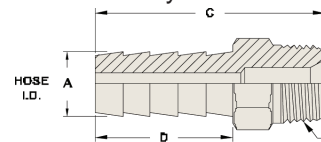
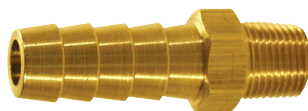

## NPTF- MALE HOSE BARB

*National Pipe Tapered - Dryseal*

Standard Brass Part Number	SS	BSPT	Hose ID A	NPTF ** Thread B	Length C	Hex	Number of Barbs	Barb Length D	Std. Pkg.	Lbs. per 100 pcs.
1020202C	SS		1/8	1/8-27	1.06	7/16	3	.46	100 *	1.8
1020204C				1/4-18	1.16	9/16	3	.46	100	3.1
1020302C	SS		3/16	1/8-27	1.35	7/16	3	.75	100 *	2.2
1020304C	SS			1/4-18	1.54	9/16	3	.75	100 *	4.0
1020402C	SS	BSPT	1/4	1/8-27	1.57	1/2	4	.97	100 *	2.9
1020404C	SS	BSPT		1/4-18	1.76	9/16	4	.97	100 *	4.3
1020406C	SS			3/8-18	1.76	11/16	4	.97	100 *	5.4
1020408C				1/2-14	1.97	7/8	4	.97	50	13.8
1020502C	SS		5/16	1/8-27	1.57	1/2	4	.97	100 *	2.9
1020504C	SS			1/4-18	1.76	9/16	4	.97	50 *	4.3
1020506C	SS			3/8-18	1.76	11/16	4	.97	50 *	5.6
1020602C	SS		3/8	1/8-27	1.57	1/2	4	.97	100 *	3.8
1020604C	SS	BSPT		1/4-18	1.76	9/16	4	.97	100 *	4.8
1020606C	SS	BSPT		3/8-18	1.76	11/16	4	.97	50 *	6.1
1020608C	SS	BSPT		1/2-14	1.97	7/8	4	.97	25 *	10.8
1020612C				3/4-14	1.97	1-1/16	4	.97	25	14.9
1020804C	SS		1/2	1/4-18	1.76	5/8	4	.97	50 *	6.7
1020806C	SS	BSPT		3/8-18	1.76	11/16	4	.97	50 *	6.9
1020808C	SS	BSPT		1/2-14	1.97	7/8	4	.97	25 *	12.0
1020812C	SS			3/4-14	1.97	1-1/16	4	.97	25 *	15.7
1021006C	SS		5/8	3/8-18	1.76	11/16	4	.97	50 *	7.8
1021008C	SS			1/2-14	1.97	7/8	4	.97	25 *	11.6
1021012C	SS			3/4-14	1.97	1-1/16	4	.97	25 *	15.7
1021208C	SS		3/4	1/2-14	2.19	7/8	4	1.19	25 *	16.4
1021212C	SS	BSPT		3/4-14	2.19	1-1/16	4	1.19	20 *	18.0
1021612C	SS		1	3/4-14	2.19	1-1/16	5	1.19	20 *	25.0
1021616C		BSPT		1-11-1/2++	2.54	1-3/8	5	1.19	10 *	37.1
1022012C			1-1/4	3/4-14	2.37	1-3/8	5	1.19	10	38.7
1022016C				1-11-1/2++	2.54	1-3/8	5	1.19	5	46.9

\* 102-SS and 102-BSPT are packaged to order

**GOODYEAR**  
GOODYEARBELTING.COM

**Call Toll Free: 1-866-711-4673**  
**International: +1-727-342-5086**

**We Ship  
World Wide**

Standard Hose Fittings

103 Series

**NPTF- MALE SWIVEL HOSE BARB**  
National Pipe Tapered - Dryseal

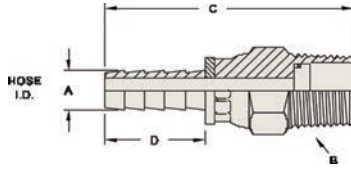

Part Number	Hose ID A	NPTF Thread B	Length C	Hex	Number of Barbs	Barb Length D	Std. Pkg.	Lbs. per 100 pcs.
1030402C	1/4	1/8-27	2.19	9/16	4	.97	100	3.5
1030404C		1/4-18	2.12	9/16	4	.97	100	6.0
1030604C	3/8	1/4-18	2.12	9/16	4	.97	100	6.6
1030606C		3/8-18	2.12	11/16	4	.97	50	8.4
1030806C	1/2	3/8-18	2.12	11/16	4	.97	50	9.7
1030808C		1/2-14	2.33	7/8	4	.97	25	14.1
1031212C	3/4	3/4-14	2.33	1-1/16	4	.97	20	20.7
1031616C	1	1-11-1/2 +	3.43	1-3/8	5	1.19	10	40.0

Note: Swivel for assembly convenience only, not for live swivel applications, 120 maximum PSI  
+ capped threads

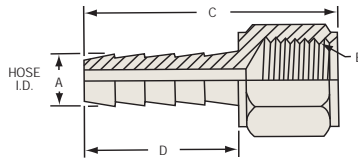

104 Series  
360 CDA Brass

**NPTF- FEMALE HOSE BARB - SOLID**  
National Pipe Tapered - Dryseal

Part Number	303 SS	Hose ID A	NPTF ** Thread B	Length C	Hex	Number of Barbs	Barb Length D	Std. Pkg.	Lbs. per 100 pcs.
1040202C		1/8	1/8-27	.96	1/2	3	.46	100	2.1
1040204C			1/4-18	1.15	5/8	3	.46	100	4.0
1040302C		3/16	1/8-27	1.25	1/2	3	.75	100	2.4
1040304C			1/4-18	1.44	5/8	3	.75	100	4.3
1040402C	SS	1/4	1/8-27	1.47	1/2	4	.97	100	2.8
1040404C			1/4-18	1.66	5/8	4	.97	100 *	4.6
1040406C			3/8-18	1.66	3/4	4	.97	50	5.6
1040408C			1/2-14	1.66	15/16	4	.97	50	8.1
1040502C		5/16	1/8-27	1.47	9/16	4	.97	100	3.6
1040504C			1/4-18	1.66	5/8	4	.97	100	4.7
1040506C			3/8-18	1.66	3/4	4	.97	50	5.7
1040602C	SS	3/8	1/8-27	1.47	9/16	4	.97	100	4.2
1040604C			1/4-18	1.66	5/8	4	.97	50 *	5.4
1040606C			3/8-18	1.66	3/4	4	.97	50 *	6.3
1040608C			1/2-14	1.66	15/16	4	.97	50	8.8
1040612C		1/2	3/4-14	1.97	1-3/16	4	.97	25	20.6
1040804C			1/4-18	1.66	5/8	4	.97	50	6.2
1040806C			3/8-18	1.66	3/4	4	.97	50	7.3
1040808C			1/2-14	1.66	15/16	4	.97	50 *	9.3
1040812C		3/4	3/4-14	1.97	1-3/16	4	.97	25 *	25.8
1041006C			3/8-18	1.66	3/4	4	.97	50 *	7.5
1041008C			1/2-14	1.66	3/4	4	.97	25 *	10.0
1041012C		1	3/4-14	1.97	1-3/16	4	.97	25 *	20.6
1041208C			1/2-14	1.88	15/16	4	1.19	25 *	12.5
1041212C		1	3/4-14	2.19	1-3/16	4	1.19	20 *	22.6
1041612C			3/4-14	2.19	1-3/16	5	1.19	20 *	26.1
1041616C		1-11-1/2	1-11-1/2	2.32	1-3/16	5	1.19	10 *	34.7
1042016C			1-11-1/2	2.32	1-7/16	5	1.19	10	43.7

105 Series

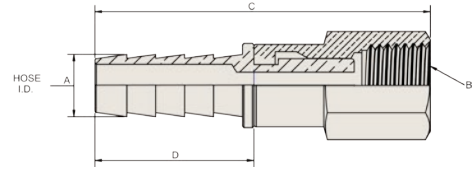

**PTF-SAE SHORT - FEMALE SWIVEL HOSE BARB**

*Short Pipe Tapered - Dryseal*

Part Number	Hose ID A	PTF-SAE Thread B	Over All Length C	Hex	Number of Barbs	Barb Length D	Std. Pkg.	Lbs. per 100 pcs.
1050404C	1/4	1/4-18	2.20	5/8	4	.97	50	5.6
1050604C	3/8	1/4-18	2.20	5/8	4	.97	50	6.2
1050606C		3/8-18	2.20	3/4	4	.97	50	8.7
1050806C	1/2	3/8-18	2.20	3/4	4	.97	50	8.7
1050808C		1/2-14	2.40	15/16	4	.97	25	14.3

Note: Swivel for assembly convenience only, not for live swivel applications.

124 Series

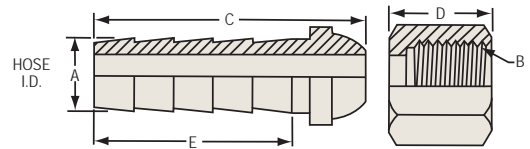

**NPSM - FEMALE SWIVEL HOSE BARB**

*National Pipe Straight - Ball Seat Type*

Part Number	Hose ID A	NPSM Thread B	Stem Length C	Nut Length D	Hex	Number of Barbs	Barb Length E	Std. Pkg.	Lbs. per 100 pcs.
1240202K	1/8	1/8-27	.79	.44	1/2	3	.46	100	2.3
1240302K	3/16	1/8-27	1.08	.44	1/2	3	.75	100	2.6
1240304K		1/4-18	1.17	.53	5/8	3	.75	100	4.5
1240402K	1/4	1/8-27	1.30	.44	1/2	4	.97	100	3.0
1240404K		1/4-18	1.39	.53	5/8	4	.97	100	4.8
1240406K	5/16	3/8-18	1.41	.63	3/4	4	.97	100	6.7
1240504K		1/4-18	1.39	.53	5/8	4	.97	100	5.0
1240506K	3/8-18	1.41	.63	3/4	4	.97	50	6.6	
1240604K	3/8	1/4-18	1.37	.53	5/8	4	.97	100	4.9
1240606K		3/8-18	1.45	.63	3/4	4	.97	100	7.1
1240608K	1/2	1/2-14	1.54	.69	15/16	4	.97	100	12.4
1240806K		3/8-18	1.42	.63	3/4	4	.97	50	7.5
1240808K	1/2-14	1.54	.69	15/16	4	.97	100	12.7	
1241212K	3/4	3/4-14	1.69	.75	1-1/8	4	1.19	50	17.4

126 Series

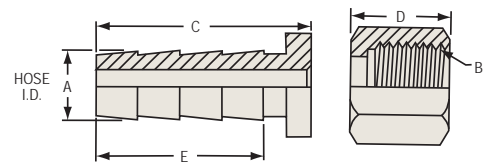

**NPSM - FEMALE SWIVEL HOSE BARB**

*National Pipe Straight - Gasket Seat Type*

Part Number	Hose ID A	NPSM Thread B	Stem Length C	Nut Length D	Hex	Number of Barbs	Barb Length E	Std. Pkg.	Lbs. per 100 pcs.
1260202C	1/8	1/8-27	.69	.44	1/2	3	.46	100	2.2
1260302C	3/16	1/8-27	.98	.44	1/2	3	.75	100	2.5
1260304C		1/4-18	.98	.53	5/8	3	.75	100	4.0
1260402C	1/4	1/8-27	1.20	.44	1/2	4	.97	100	2.7
1260404C		1/4-18	1.20	.53	5/8	4	.97	100	4.3
1260406C	5/16	3/8-18	1.22	.63	3/4	4	.97	100	6.0
1260504C		1/4-18	1.20	.53	5/8	4	.97	100	4.2
1260604C	3/8	1/4-18	1.20	.53	5/8	4	.97	100	4.6
1260606C		3/8-18	1.22	.63	3/4	4	.97	50	6.4
1260608C	1/2	1/2-14	1.22	.69	15/16	4	.97	50	10.4
1260806C		3/8-18	1.22	.63	3/4	4	.97	50	7.0
1260808C	1/2-14	1.22	.69	15/16	4	.97	50	11.0	
1261212C	3/4	3/4-14	1.47	.75	1-1/8	4	1.19	25	15.6

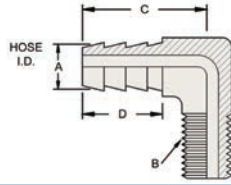

**90° ELBOW- Forged**  
Hose Barb to Male NPTF

Part Number	Hose ID A	NPTF Thread B	Length Centerline C	Number of Barbs	Barb Length D	Std. Pkg.	Lbs. per 100 pcs.
1290302C	3/16	1/8-27	1.05	3	.79	50	3.3
1290402C		1/8-27	1.05	3	.79	50	3.4
1290404C	1/4	1/4-18	1.14	3	.79	50	6.2
1290406C		3/8-18	1.16	3	.79	50	7.3
1290502C		1/8-27	1.05	3	.79	25	3.1
1290504C	5/16	1/4-18	1.14	3	.79	50	6.1
1290506C		3/8-18	1.16	3	.79	50	6.5
1290602C		1/8-27	1.09	3	.87	50	3.6
1290604C	3/8	1/4-18	1.14	3	.87	50	6.6
1290606C		3/8-18	1.22	3	.87	50	8.9
1290608C		1/2-14	1.29	3	.87	25	13.1
1290804C		1/4-18	1.17	3	.87	50	6.3
1290806C	1/2	3/8-18	1.24	3	.87	50	8.3
1290808C		1/2-14	1.29	3	.87	25	12.3
1291006C	5/8	3/8-18	1.31	3	.87	25	17.2
1291008C		1/2-14	1.36	3	.87	25	18.6
1291208C	3/4	1/2-14	1.36	3	.87	25	23.2
1291212C		3/4-14	1.44	3	.87	25	21.5
1291612C	1	3/4-14	1.65	4	.98	10	37.1
1291616C		1-11-1/2 ++	1.69	4	.98	10	42.5

++Capped

129-SS (316 stainless) Series

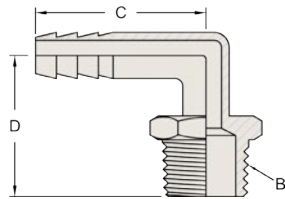

**90° ELBOW - Casting**  
Hose Barb to Male NPT

Part Number	Hose ID A	NPT Thread B	Length Centerline C	Number of Barbs	Height Centerline D	Lbs. per 100 pcs.
1290402SS	1/4	1/8-27	1.1	3	.85	3.5
1290404SS	1/4	1/4-18	1.47	4	1.11	7.0
1290604SS	3/8	1/4-18	1.25	3	1.01	7.4
1290606SS	3/8	3/8-18	1.38	3	1.17	9.3
1290804SS	1/2	1/4-18	1.45	4	1.50	6.6
1290806SS	1/2	3/8-18	1.60	4	1.25	8.8
1290808SS	1/2	1/2-14	1.64	4	1.42	12.6
1291208SS	3/4	1/2-14	1.87	4	1.45	23.6
1291212SS	3/4	3/4-14	1.96	4	1.65	21.7

129-SS parts are packaged to order

134 Series

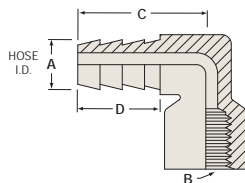

**90° ELBOW- Forged**  
Hose Barb to Female NPTF

Part Number	Hose ID A	NPTF Thread B	Length Centerline C	Number of Barbs	Barb Length D	Std. Pkg.	Lbs. per 100 pcs.
1340402C		1/8-27	1.05	3	.79	50	6.9
1340404C	1/4	1/4-18	1.14	3	.79	50	8.1
1340604C		1/4-18	1.14	3	.79	50	9.4
1340606C	3/8	3/8-18	1.22	3	.79	50	12.5
1340804C		1/4-18	1.17	3	.87	25	9.4
1340806C	1/2	3/8-18	1.24	3	.89	25	12.5

139 Series

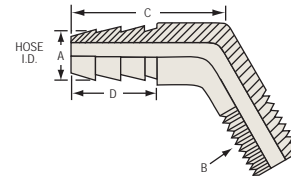

**45° ELBOW- Forged**  
Hose Barb to Male NPTF

Part Number	Hose ID A	NPTF Thread B	Length Centerline C	Number of Barbs	Barb Length D	Std. Pkg.	Lbs. per 100 pcs.
1390402C	1/4	1/8-27	.96	3	.79	100	3.4
1390404C		1/4-18	1.01	3	.79	25	6.2
1390602C	3/8	1/8-27	1.03	3	.87	100	3.6
1390604C		1/4-18	1.05	3	.87	100	6.6
1390606C		3/8-18	1.10	3	.87	25	8.9
1390804C	1/2	1/4-18	1.10	3	.87	25	6.3
1390806C		3/8-18	1.10	3	.87	25	8.3
1390808C		1/2-14	1.15	3	.87	50	12.3
1391208C		3/4	1/2-14	1.15	3	.87	25

142 Series

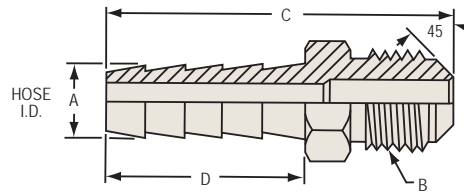

**MALE HOSE BARB**  
45° SAE

Part Number	Hose ID A	Tube OD	UNF Thread B	Length C	Hex	Number of Barbs	Barb Length D	Std. Pkg.	Lbs. per 100 pcs.
1420307C	3/16	1/4	7/16-20	1.50	7/16	3	.75	100	2.7
1420407C	1/4	1/4	7/16-20	1.72	7/16	4	.97	100	3.2
1420410C		3/8	5/8-18	1.82	5/8	4	.97	100	6.6
1420508C	5/16	5/16	1/2-20	1.75	1/2	4	.97	100	4.5
1420610C	3/8	3/8	5/8-18	1.82	5/8	4	.97	50	7.6
1420612C		1/2	3/4-16	1.97	3/4	4	.97	50	9.9
1420812C		1/2	1/2	3/4-16	1.97	3/4	4	.97	50

143 Series

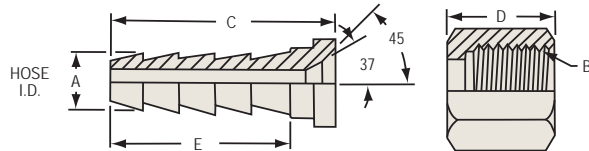

**FEMALE SWIVEL HOSE BARB**  
45° SAE / 37° JIC (Dual Angle Seat)

Part Number	Hose ID A	Tube OD	UNF Thread B	Stem Length C	Nut Length D	Hex	Number of Barbs	Barb Length E	Std. Pkg.	Lbs. per 100 pcs.
1430307K	3/16	1/4	7/16-20	1.03	.60	9/16	3	.75	100	3.8
1430407K	1/4	1/4	7/16-20	1.25	.60	9/16	4	.97	100	4.1
1430408K		5/16	1/2-20	1.31	.68	5/8	4	.97	100	5.1
1430508K	5/16	5/16	1/2-20	1.31	.68	5/8	4	.97	100	5.1
1430612K	3/8	1/2	3/4-16	1.34	.84	7/8	4	.97	100	10.2
1430812K	1/2	1/2	3/4-16	1.34	.84	7/8	4	.97	100	10.9



144 Series

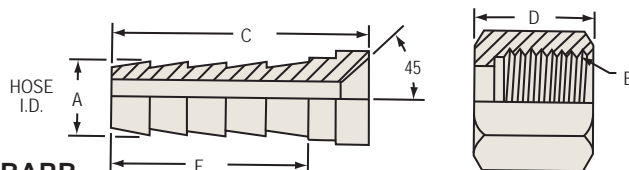

**FEMALE SWIVEL HOSE BARB**  
45° SAE

Part Number	Hose ID A	Tube OD	UNF Thread B	Stem Length C	Nut Length D	Hex	Number of Barbs	Barb Length E	Std. Pkg.	Lbs. per 100 pcs.
1440306K	3/16	3/16	3/8-24	1.03	.45	7/16	3	.75	100	2.0
1440410K	1/4	3/8	5/8-18	1.27	.68	3/4	4	.97	100	6.7
1440510K	5/16	3/8	5/8-18	1.27	.68	3/4	4	.97	100	6.7
1440610K	3/8	3/8	5/8-18	1.27	.68	3/4	4	.97	100	7.2
1440812K	1/2	1/2	3/4-16	1.34	.84	7/8	4	.97	100	10.9
1441217K	3/4	3/4	1-1/16 - 14	1.47	1.03 *	1-1/4	4	.97	25	25.0

\* Notch in nut for SAE identification

145 Series

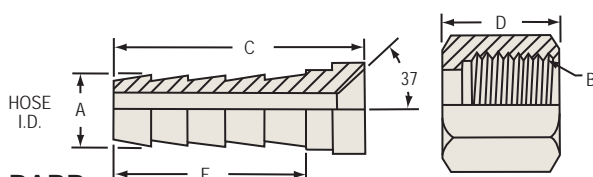

**FEMALE SWIVEL HOSE BARB**  
37° JIC

Part Number	Hose ID A	Tube OD	UNF Thread B	Stem Length C	Nut Length D	Hex	Number of Barbs	Barb Length E	Std. Pkg.	Lbs. per 100 pcs.
1450609K	3/8	3/8	9/16-18	1.24	.63	11/16	4	.97	100	6.0
1451217K	3/4	3/4	1-1/16 - 12	1.47	1.03	1-1/4	4	.97	25	25.0

177 Series

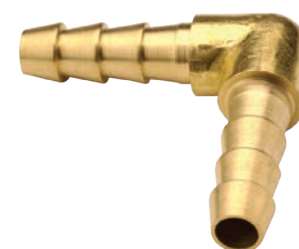
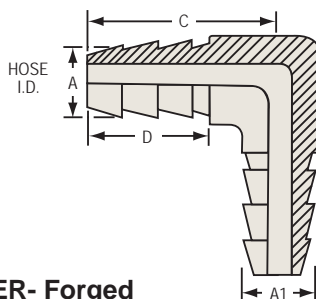

**HOSE BARB 90° ELBOW SPLICER- Forged**

Part Number	Hose ID A	Hose ID A1	Length Centerline C	Number of Barbs	Barb Length D	Std. Pkg.	Lbs. per 100 pcs.
1770202C	1/8	1/8	.73	3	.46	25	2.5
1770303C	3/16	3/16	1.05	3	.79	25	3.1
1770402C	1/4	1/8	1.05	3	.79	25	3.1
1770404C		1/4	1.05	3	.79	25	3.0
1770505C	5/16	5/16	1.15	3	.79	25	4.9
1770604C	3/8	1/4	1.15	3	.79	25	6.2
1770606C		3/8	1.15	3	.79	25	5.0
1770806C	1/2	3/8	1.25	3	.87	25	8.7
1770808C		1/2	1.25	3	.87	25	9.3
1771010C	5/8	5/8	1.30	3	.87	25	15.6
1771208C	3/4	1/2	1.41	3	.89	25	20.6

## 177-SS (304 stainless) Series

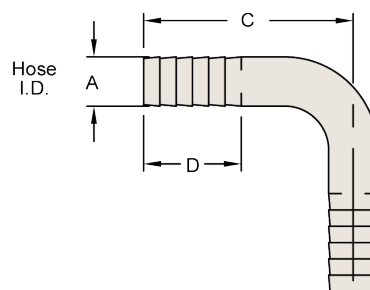

## HOSE BARB 90° ELBOW SPLICER

Part Number	Hose ID A	Barb Length D	Length Centerline C	Number of Barbs	Lbs. per 100 pcs.
1770202SS	1/8	.36	.85	3	0.6
1770303SS	3/16	.54	1.68	5	1.9
1770404SS	1/4	.54	1.14	5	2.5
1770606SS	3/8	.56	1.46	5	4.0
1770808SS	1/2	.58	2.24	5	8.2

177-SS parts are packaged to order

## 178 and 178-SS (316 stainless) Series

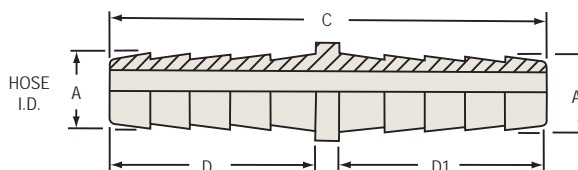

## HOSE SPLICER

Part Number	SS	Hose ID A	Hose ID A1	Length C	Number of Barbs	Barb Length D	Barb Length D1	Std. Pkg.	Lbs. per 100 pcs.
1780202C		1/8	1/8	.97	3	.46	.46	100	0.6
1780303C		3/16	3/16	1.56	3	.75	.75	100	1.3
1780402C		1/4	1/8	1.55	4	.97	.46	100	2.0
1780404C	SS	1/4	1/4	2.03	4	.97	.97	100 *	2.3
1780505C		5/16	5/16	2.06	4	.97	.97	100	2.5
1780604C		3/8	1/4	2.06	4	.97	.97	100	3.7
1780606C	SS	3/8	3/8	2.06	4	.97	.97	100 *	4.0
1780806C		1/2	3/8	2.06	4	.97	.97	100	6.2
1780808C	SS	1/2	1/2	2.06	4	.97	.97	50 *	6.5
1781006C			3/8	2.06	4	.97	.97	50	6.2
1781008C		5/8	1/2	2.06	4	.97	.97	50	6.8
1781010C			5/8	2.06	4	.97	.97	50	7.0
1781208C		3/4	1/2	2.28	4	1.19	.97	25	10.6
1781212C	SS	3/4	3/4	2.50	4	1.19	1.19	25 *	12.8
1781616C		1	1	3.00	5	1.44	1.44	10	22.5

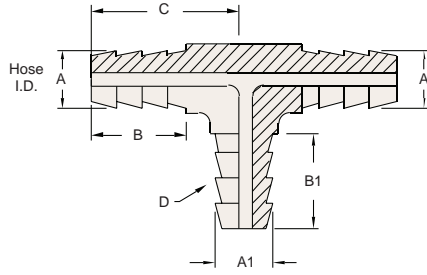

1790604C

**HOSE BARB- Forged  
TEE SPLICER**

Part Number	Hose ID A	Hose ID A1	Barb Length B	Barb Length B1	Length Centerline C	NPTF Thread D	Number of Barbs	Std. Pkg.	Lbs. per 100 pcs.
1790202C	1/8	1/8	.46	.46	.71	--	3	25	3.1
1790303C	3/16	3/16	.71	.71	.94	--	3	100	3.1
1790402C	1/4	1/8	.71	.46	.94	--	3	25	4.4
1790404C		1/4	.71	.71	.94	--	3	25	3.4
1790505C	5/16	5/16	.79	.79	1.18	--	3	25	6.4
1790604C *		--	.86	--	1.26	1/4-18	3	25	11.2
1790604BARB	3/8	1/4	.86	.71	1.26	--	3	25	6.5
1790606C		3/8	.86	.86	1.26	--	3	25	8.0
1790806C	1/2	3/8	.90	.90	1.26	--	3	25	10.0
1790808C		1/2	.86	.86	1.26	--	3	25	10.4
1791010C	5/8	5/8	.90	.90	1.33	--	3	25	15.8
1791208C	3/4	1/2	.90	.90	1.41	--	3	25	22.5
1791212C		3/4	.90	.90	1.41	--	3	20	37.0

\* 1790604C as pictured above

179-SS (304 stainless) Series

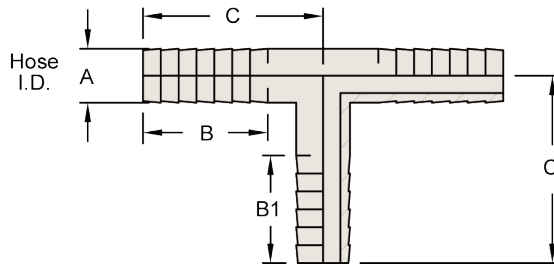

**HOSE BARB  
TEE SPLICER**

Part Number	Hose ID A	Barb Length B	Barb Length B1	Length Centerline C	Number of Barbs	Lbs. per 100 pcs.
1790202SS	1/8	.50	.50	.62	4	1.3
1790303SS	3/16	.56	.56	.70	5	1.5
1790404SS	1/4	.63	.56 *	.94	6 / 5 *	2.5
1790606SS	3/8	.55	.55	1.01	5	3.2
1790808SS	1/2	.59	.55	1.01	5	5.6

\* On Drop - 5 Barbs

179-SS parts are made-to-order

# Welding Hose Fittings

## Features:

- Dixon Brass offers 16 welding hose fitting in 4 different series.
- Our welding hose fittings are manufactured to exacting specifications.
- All welding hose fittings are packaged for easy storage and identification. Female swivel welding hose fittings (152 and 154 series) are sold in stem and swivel nut sets. Pricing information on separate components is available upon request.
- It is recommended that hose assemblies be fabricated using hose clamps or crimped ferrules in conjunction with hose barbs.

The following letter size designations are commonly used for both oxygen and fuel gas fitting size identification:

**A-Size 3/8-24 UNF**  
**B-Size 9/16-18 UNF**

## 152 Series

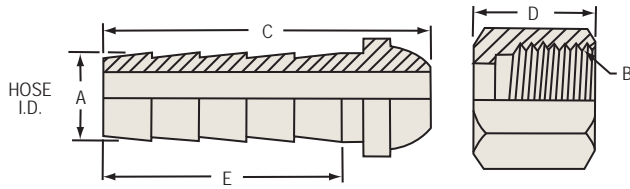

### WELDING HOSE COUPLING

*Right Hand Thread for Oxygen Line*

Part Number	Hose ID A	Right UNF Thread B	Stem Length C	Nut Length D	Hex	Number of Barbs	Barb Length E	Std. Pkg.	Lbs. per 100 pcs.
1520306K	3/16	3/8-24	1.32	.45	7/16	4	.97	100	2.3
1520309K		9/16-18	1.43	.63	11/16	4	.97	100	6.1
1520409K	1/4	9/16-18	1.43	.63	11/16	4	.97	100	6.2
1520509K	5/16	9/16-18	1.43	.63	11/16	4	.97	100	6.6
1520609K	3/8	9/16-18	1.43	.63	11/16	4	.97	100	6.9

## 154 Series

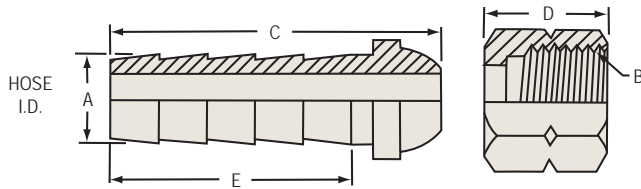

### WELDING HOSE COUPLING

*Left Hand Thread for Acetylene Line*

Part Number	Hose ID A	Left UNF Thread B	Stem Length C	Nut Length D	Hex	Number of Barbs	Barb Length E	Std. Pkg.	Lbs. per 100 pcs.
1540306K	3/16	3/8-24	1.32	.45	7/16	4	.97	100	2.3
1540309K		9/16-18	1.43	.63	11/16	4	.97	100	6.1
1540409K	1/4	9/16-18	1.43	.63	11/16	4	.97	100	6.2
1540509K	5/16	9/16-18	1.43	.63	11/16	4	.97	100	6.6
1540609K	3/8	9/16-18	1.43	.63	11/16	4	.97	100	6.9

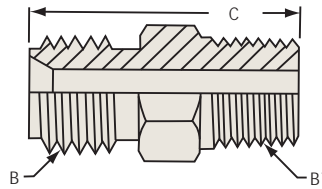

**WELDING HOSE ADAPTER**

*Right Hand Thread*

Part Number	Right UNF Thread B	NPTF Thread B'	Length C	Hex	Std. Pkg.	Lbs. per 100 pcs.
1560904C	9/16-18	1/4-18	1.30	5/8	100	5.8
1560906C	9/16-18	3/8-18	1.30	11/16	50	8.9

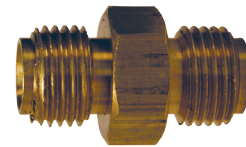
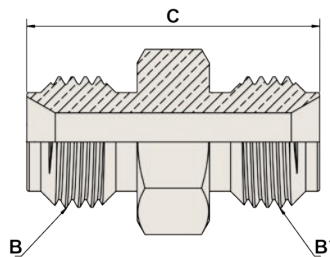

**WELDING HOSE CONNECTOR**

*Right Hand Thread*

Part Number	Right UNF Thread B	Right UNF Thread B'	Length C	Hex	Std. Pkg.	Lbs. per 100 pcs.
1560909C	9/16-18	9/16-18	1.25	11/16	100	6.9

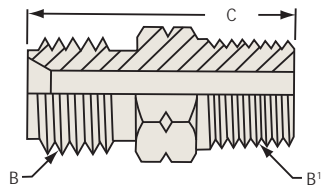

**WELDING HOSE ADAPTER**

*Left Hand Thread*

Part Number	Left UNF Thread B	NPTF Thread B'	Length C	Hex	Std. Pkg.	Lbs. per 100 pcs.
1580904C	9/16-18	1/4-18	1.30	5/8	100	5.8
1580906C	9/16-18	3/8-18	1.30	11/16	50	8.9

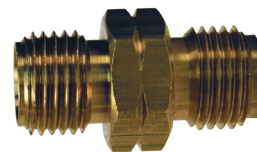
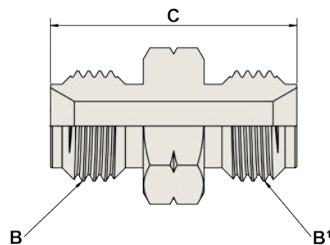

**WELDING HOSE CONNECTOR**

*Left Hand Thread*

Part Number	Left UNF Thread B	Left UNF Thread B'	Length C	Hex	Std. Pkg.	Lbs. per 100 pcs.
-------------	-------------------	--------------------	----------	-----	-----------	-------------------

# Brass Ferrules and Crimping Tool

200 Series

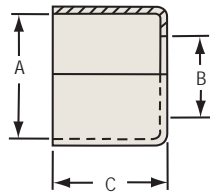

## STAMPED BRASS FERRULE

Part Number	Reference No.	Ferrule ID A	Ferrule Length C	Hole Size B	Gauge	Std. Pkg. *	Lbs. per 100 pcs.
2004000C	619	.400	.47	.27	.020	100	.40
2004530C	769	.450	.56	.34	.016	50	.44
2004750C	4750	.478	.69	.33	.024	50	.76
2005000C	624	.500	.50	.34	.016	50	.40
2005005C	7322	.500	1.00	.34	.024	50	1.20
2005250C	625	.525	.50	.34	.016	50	.42
2005255C	7323	.525	1.00	.38	.024	50	1.18
2005310C	7324	.531	1.00	.44	.024	50	1.20
2005500C	626	.550	.48	.38	.016	50	.42
2005620C	7325	.562	1.00	.44	.024	50	1.28
2005930C	7326	.593	1.00	.44	.024	50	1.34
2006250C	II	.625	.50	.50	.019	50	.58
2006255C	7327	.625	1.00	.44	.024	50	1.44
2006500C	HH	.650	.50	.50	.019	50	.60
2006560C	7328	.656	1.00	.44	.024	50	1.48
2006750C	GG	.675	.52	.50	.019	100	.86
2006900C	7329	.687	1.00	.50	.024	50	1.52
2007180C	7330A	.718	1.00	.63	.024	50	1.62
2007250C	EE	.725	.53	.50	.019	50	.76
2007500C	DD	.750	.53	.50	.019	50	.96
2007505C	7331	.750	1.00	.63	.024	50	1.74
2007750C	CC	.775	.53	.50	.016	50	.90
2007810C	7332	.781	1.00	.63	.024	50	1.84
2008120C	7333	.812	1.00	.63	.024	50	1.94
2008750C	7244A	.875	.84	.69	.024	25	1.66
2009250C	7113	.925	.84	.69	.025	50	1.86
2009750C	5028A	.975	.84	.69	.024	25	1.96
2009950C	7104A	1.150	.84	.88	.024	50	2.36
2001025C	7114A	1.025	.84	.69	.024	25	2.40
2001100C	5027	1.100	.84	.81	.023	25	2.40
2001175C	7088A	1.175	.84	.88	.024	25	2.50
2001225C	875K	1.225	.875	.875	.025	25	2.50
2001500C	1500	1.500	.875	1.12	.025	25	3.50

\* Sold in full bag quantity only



## 200FC FERRULE CRIMPING TOOL

Standard Die Part Number	Bore Die *	Hose OD **
200FC6A	.625	.640 - .671
200FC5	.578	.590 - .625
200FC4B	.531	.540 - .562
200FC4A	.484	.490 - .520

### Features:

- Professional quality ferrule crimper provides fixed mount production capability or job-site portability
- Shipped with 5 standard die sets for 1/4" single braid hose through 3/8" 2-braid hose
- Optional die sets available for 3/16" and 1/2" hoses

Optional Die Part Number	Bore Die *	Hose OD **
200FC3	.375	.385 - .406
200FC8A	.750	.760 - .781
200FC8B	.812	.820 - .843

\* See ferrule ID above

**GOODYEAR**  
GOODYEARBELTING.COM

**Call Toll Free: 1-866-711-4673**  
**International: +1-727-342-5086**

**We Ship**  
**World Wide**

# Re-usable Hose Fittings

## Applications:

Reusable fittings are used when a more durable hose connection is required or ease of making a repair is a major consideration.

## Features:

- Dixon Brass offers over 110 re-usable fittings in 10 different series.
- All re-usable fittings are of heavy duty construction.

Three variables must be determined before ordering.

1. I.D. of hose to be used with fitting
2. O.D. of hose to be used with fitting
3. Connection thread size desired

Part number for re-usable hose fitting sets (183, 185 and 187) series are easy to understand and use. The first three digits of the seven digit part number signify a specific product series. The fourth digit signifies the hose I.D. used with the fitting (measured in sixteenths of an inch). The fifth and sixth digits signify the hose O.D. used with the fitting (measured in sixteenths of an inch).

Note: Recommended for rubber covered hose only.

## How to Use Dixon Brass Reusable Hose Fitting Part Numbers

1836116

1836116

1836116

1836116

## SERIES IDENTIFICATION

HOSE I.D. (Measured in sixteenths of an inch)

HOSE O.D. (Measured in sixteenths of an inch)

THREAD SIZE (Measured in sixteenths of an inch)

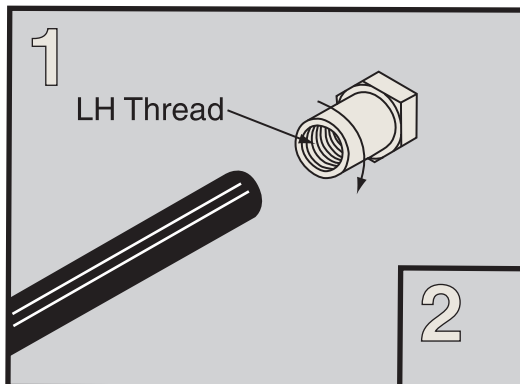

Simply slip and twist ferrule on end of hose which has been trimmed flush. No skiving necessary.

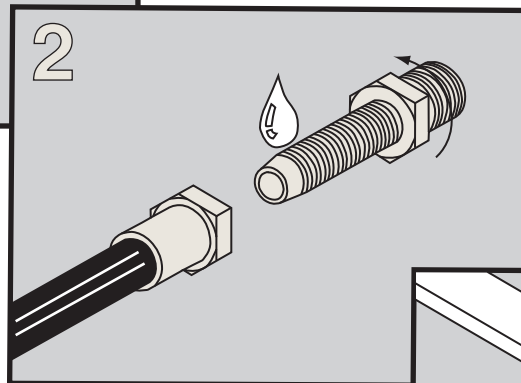

Apply a drop or two of lubricant to fitting before inserting ferrule.

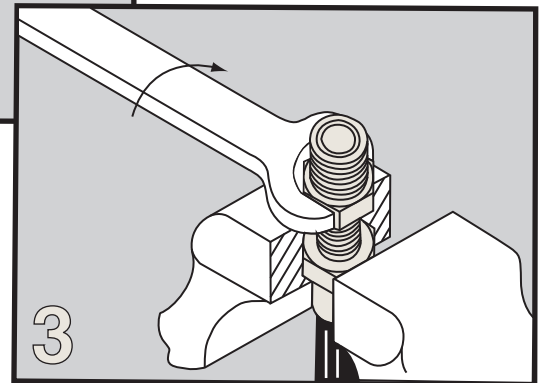

Turn reusable fitting into ferrule. Hose is expanded inside ferrule for perfect fit.

## How to Install Reusable Fittings without Skiving or Crimping

**GOODYEAR**  
GOODYEARBELTING.COM

Call Toll Free: 1-866-711-4673  
International: +1-727-342-5086

**We Ship  
World Wide**

## 180 and 180-SS Series

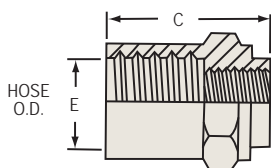

### REUSABLE FERRULE

Standard Brass Part Number	303 SS	Hose ID	Hose OD E	Length C	Hex	Std. Pkg.	Lbs. per 100 pcs.
1800408F	SS		1/2	1.02	11/16	100 *	5.3
1800409F	SS	1/4	9/16	1.02	3/4	50 *	6.3
1800410F	SS		5/8	1.02	13/16	50 *	7.3
1800509F	SS		9/16	1.10	3/4	100 *	6.6
1800510F	SS	5/16	5/8	1.10	13/16	50 *	7.8
1800511F	SS		11/16	1.10	7/8	50	8.6
1800610F	SS		5/8	1.10	13/16	50 *	7.2
1800611F	SS	3/8	11/16	1.10	7/8	50 *	8.3
1800612F	SS		3/4	1.10	7/8	50 *	6.7
1800814F	SS		7/8	1.69	1-1/16	25 *	15.8
1800815F	SS	1/2	15/16	1.69	1-1/8	25 *	17.5
1800816F	SS		1	1.69	1-3/16	20	19.5

\* 180-SS packaged to order

## 182 and 182-SS Series

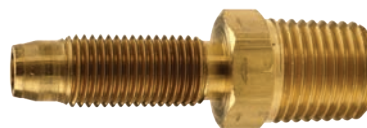
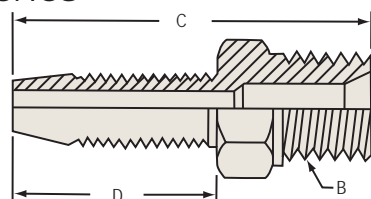

### REUSABLE MALE STEM

Standard Brass Part Number	303 SS	Hose ID	NPTF ** Thread B	Length C	Stem Length D	Hex	Std. Pkg.	Lbs. per 100 pcs.
1820402S	SS		1/8-27	1.68	1.07	9/16	100 *	4.1
1820404S	SS	1/4	1/4-18	1.86	1.07	9/16	100 *	5.1
1820406S	SS		3/8-18	1.86	1.07	11/16	50	6.5
1820504S	SS	5/16	1/4-18	1.96	1.17	9/16	50 *	5.5
1820506S	SS		3/8-18	1.96	1.17	11/16	50	6.9
1820604S	SS		1/4-18	1.96	1.17	9/16	100 *	6.4
1820606S	SS	3/8	3/8-18	1.96	1.17	11/16	50 *	7.8
1820608S	SS		1/2-14	2.17	1.17	7/8	25	12.7
1820804S	SS		1/4-18	2.43	1.64	11/16	50	12.3
1820806S	SS	1/2	3/8-18	2.43	1.64	11/16	50 *	11.0
1820808S	SS		1/2-14	2.64	1.64	7/8	25 *	16.3

\* 182-SS packaged to order

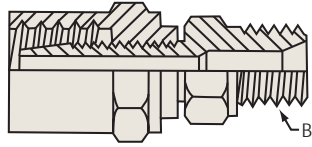

**REUSABLE MALE FITTING - UNASSEMBLED**

Standard Brass Part Number	303 SS	Hose ID	Hose OD	NPTF ** Thread B	Stem Hex	Ferrule Hex	Std. Pkg.	Lbs. per 100 pcs.
1834082K	SS		1/2	1/8-27	9/16	11/16	100 *	9.4
1834092K	SS	1/4	9/16	1/8-27	9/16	3/4	100 *	10.5
1834102K	SS		5/8	1/8-27	9/16	13/16	100 *	11.4
1834084K	SS		1/2	1/4-18	9/16	11/16	50 *	10.4
1834094K	SS	1/4	9/16	1/4-18	9/16	3/4	50 *	11.4
1834104K	SS		5/8	1/4-18	9/16	13/16	50 *	12.3
1834086K			1/2	3/8-18	11/16	11/16	50	11.8
1834096K		1/4	9/16	3/8-18	11/16	3/4	50	12.8
1834106K			5/8	3/8-18	11/16	13/16	50	13.8
1835094K	SS		9/16	1/4-18	9/16	3/4	50 *	12.1
1835104K	SS	5/16	5/8	1/4-18	9/16	13/16	50 *	13.4
1835114K			11/16	1/4-18	9/16	7/8	50	14.1
1835096K			9/16	3/8-18	11/16	3/4	50	13.5
1835106K		5/16	5/8	3/8-18	11/16	13/16	50	14.7
1835116K			11/16	3/8-18	11/16	7/8	50	15.5
1836104K	SS		5/8	1/4-18	9/16	13/16	50 *	13.6
1836114K	SS	3/8	11/16	1/4-18	9/16	7/8	50 *	14.7
1836124K	SS		3/4	1/4-18	9/16	7/8	50 *	13.1
1836106K	SS		5/8	3/8-18	11/16	13/16	50 *	15.0
1836116K	SS	3/8	11/16	3/8-18	11/16	13/16	50 *	16.1
1836126K	SS		3/4	3/8-18	11/16	7/8	50 *	14.6
1836108K			5/8	1/2-14	7/8	13/16	50	19.9
1836118K		3/8	11/16	1/2-14	7/8	7/8	50	21.0
1836128K			3/4	1/2-14	7/8	7/8	50	19.4
1838144K			7/8	1/4-18	11/16	1-1/16	25	28.1
1838154K		1/2	15/16	1/4-18	11/16	1-1/8	25	29.8
1838164K			1	1/4-18	11/16	1-3/16	25	31.8
1838146K	SS		7/8	3/8-18	11/16	1-1/16	25 *	26.8
1838156K	SS	1/2	15/16	3/8-18	11/16	1-1/8	25 *	28.5
1838166K			1	3/8-18	11/16	1-3/16	25	30.5
1838148K	SS		7/8	1/2-14	7/8	1-1/16	20 *	32.1
1838158K	SS	1/2	15/16	1/2-14	7/8	1-1/8	20 *	33.8
1838168K			1	1/2-14	7/8	1-3/16	20	35.8

\* 183-SS packaged to order

\*\* NPT thread on 183-SS

184 Series

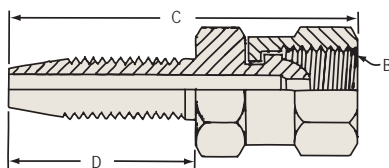

**REUSABLE FEMALE SWIVEL STEM**

Part Number	Hose ID A	NPSM Thread B	Length C	Stem Length D	Swivel Hex	Std. Pkg.	Lbs. per 100 pcs.
1840404A	1/4	1/4-18	1.94	1.07	11/16	50	7.8
1840406A		3/8-18	2.07	1.07	13/16	50	11.3
1840504A	5/16	1/4-18	2.12	1.17	11/16	50	9.4
1840604A	3/8	1/4-18	2.12	1.17	11/16	50	9.1
1840606A		3/8-18	2.20	1.17	13/16	50	12.5
1840808A	1/2	1/2-14	2.86	1.64	15/16	25	19.0

185 Series

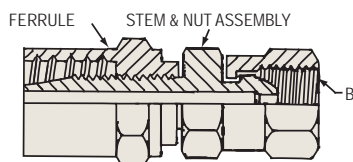

**REUSABLE FEMALE SWIVEL FITTING - UNASSEMBLED**

Part Number	Hose ID A	Hose OD	NPSM Thread B	Swivel Hex	Ferrule Hex	Std. Pkg.	Lbs. per 100 pcs.
1854084K	1/4	1/2	1/4-18	11/16	11/16	50	13.2
1854094K		9/16	1/4-18	11/16	3/4	50	14.2
1854104K		5/8	1/4-18	11/16	13/16	50	15.1
1854086K	1/4	1/2	3/8-18	13/16	11/16	50	16.6
1854096K		9/16	3/8-18	13/16	3/4	50	17.6
1854106K		5/8	3/8-18	13/16	13/16	50	18.6
1855094K	5/16	9/16	1/4-18	11/16	3/4	50	16.0
1855104K		5/8	1/4-18	11/16	13/16	50	17.3
1855114K		11/16	1/4-18	11/16	7/8	50	18.0
1856104K	3/8	5/8	1/4-18	11/16	13/16	50	16.3
1856114K		11/16	1/4-18	11/16	7/8	50	17.4
1856124K		3/4	1/4-18	11/16	7/8	50	15.8
1856106K	3/8	5/8	3/8-18	13/16	13/16	50	19.7
1856116K		11/16	3/8-18	13/16	7/8	50	20.8
1856126K		3/4	3/8-18	13/16	7/8	50	19.3
1858148K	1/2	7/8	1/2-14	15/16	1-1/16	20	34.8
1858158K		15/16	1/2-14	15/16	1-1/8	20	36.5
1858168K		1	1/2-14	15/16	1-3/16	20	38.5

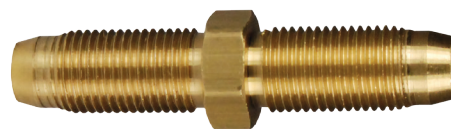
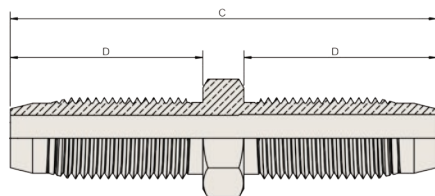

**REUSABLE SPLICER STEM**

Part Number	Hose ID	Length C	Stem Length D	Hex	Std. Pkg.	Lbs. per 100 pcs.
1860404S	1/4	2.39	1.07	9/16	100	6
1860606S	3/8	2.59	1.17	5/8	50	9

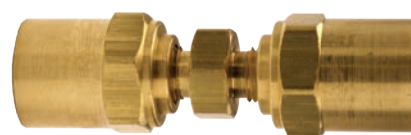
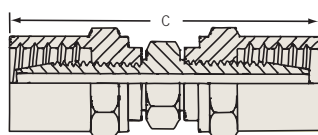

**REUSABLE HOSE SPLICER - UNASSEMBLED**

Part Number	Hose ID	Hose OD	Length C	Splicer Hex	Ferrule Hex	Std. Pkg.	Lbs. per 100 pcs.
1870408K	1/4	1/2	2.39	9/16	11/16	50	16.2
1870409K		9/16	2.39	9/16	3/4	50	18.2
1870410K		5/8	2.39	9/16	13/16	50	20.1
1870610K	3/8	5/8	2.59	5/8	13/16	25	23.1
1870611K		11/16	2.59	5/8	7/8	25	25.5
1870612K		3/4	2.59	5/8	7/8	25	22.3

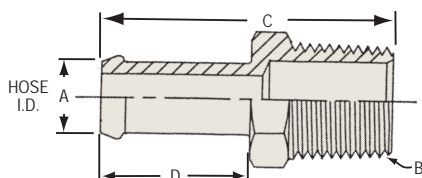

**BEADED HOSE BARBS**

Part Number	Hose ID A	NPTF Thread B	Length C	Hex	Barb Length D	Std. Pkg.	Lbs. per 100 pcs.
268B0402	1/4	1/8-27	1.18	1/2	.62	100	2.4
268B0404		1/4-18	1.41	9/16	.62	100	3.6
268B0502	5/16	1/8-27	1.22	1/2	.62	100	2.5
268B0504		1/4-18	1.41	9/16	.62	50	3.9
268B0602	3/8	1/8-27	1.48	1/2	.88	100	3.7
268B0604		1/4-18	1.67	9/16	.88	100	4.4
268B0606		3/8-18	1.67	11/16	.88	50	5.8
268B0806	1/2	3/8-18	1.67	11/16	.88	50	6.1
268B0808		1/2-14	1.88	7/8	.88	50	10.9
268B1008	5/8	1/2-14	1.88	7/8	.88	25	11.9
268B1208	3/4	1/2-14	1.88	7/8	.88	50	13.7

# Lok-on Hose Fittings

## Lok-on Hose Fittings

### Assembly Instructions

1. Trim hose end with a smooth square cut.
2. Lubricate either push-on fitting, hose or both.
3. Insert push-on fitting into hose until first barb is in the hose.
4. Place end of fitting against a flat object (bench, wall, etc.) and grip the hose one inch from the end. Push with a steady force until the end of the hose is covered by the yellow plastic cap.

### Disassembly Instructions

1. Leaving push-on fitting in place, make a 1" cut in the hose along the barbed end of the fitting. Note: Be careful not to nick barbs when cutting the hose.
2. With firm grip on hose, give a sharp downward pull to release the fitting from the hose

- CAUTION: Push-on fittings will properly grip push-on hose only when pushed all the way in, with the cut end of the hose completely concealed by the plastic cap.



## 270AT Hose Fitting Installation Tool

### Features:

- Cuts push-on style hose and inserts the fitting
- Built-in cutter slices through 1/4" - 3/4" I.D. reinforced push-on hose without fraying
- Clamp hose into tool's vice and apply light pressure on handle to drive in the fitting
- Tool has four 7/16" diameter mounting holes for bench mounting
- Overall size is 13-1/2" long x 2-3/8" wide x 7" height



Part Number	Description
270AT-RPLBlade	Replacement blade for the 270AT

## 271 Series

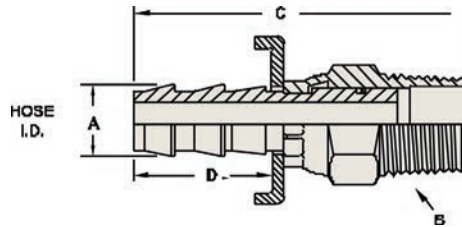

### NPTF-MALE

### SWIVEL HOSE BARB

National Pipe Tapered - Dryseal

Part Number	Hose ID A	NPTF Thread B	Length C	Hex	No. of Barbs	Barb Length D	Std. Pkg.	Lbs. per 100 pcs.
2710402C	1/4	1/8-27	2.09	9/16	2	.81	100	6.8
2710404C		1/4-18	2.02	9/16	2	.87	100	6.1
2710604C	3/8	1/4-18	2.12	9/16	2	.97	50	7.4
2710606C		3/8-18	2.12	11/16	2	.97	50	9.1
2710806C	1/2	3/8-18	2.12	11/16	2	.97	25	10.4
2710808C		1/2-14	2.33	7/8	2	.97	20	14.8
2711212C	3/4	3/4-14	2.80	1-1/16	3	1.45	10	24.8

Note: Swivel for assembly convenience only, not for live swivel applications, 120 maximum PSI

**NPTF-MALE  
HOSE BARB**

National Pipe Tapered - Dryseal

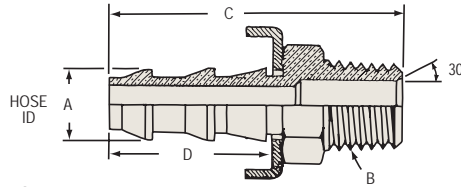

Part Number	303 SS	Hose ID A	NPTF ** Thread B	Length C	Hex	Number of Barbs	Barb Length D	Std. Pkg.	Lbs. per 100 pcs.
2720402C	SS		1/8-27	1.42	7/16	2	.77	100 *	2.7
2720404C	SS	1/4	1/4-18	1.61	9/16	2	.77	100 *	4.3
2720406C			3/8-18	1.61	11/16	2	.77	50	5.6
2720502C		5/16	1/8-27	1.42	7/16	2	.77	100	3.1
2720504C			1/4-18	1.61	9/16	2	.77	50	4.5
2720602C			1/8-27	1.60	9/16	2	.92	50	5.0
2720604C	SS		1/4-18	1.76	9/16	2	.92	50 *	5.3
2720606C	SS	3/8	3/8-18	1.76	11/16	2	.92	50 *	6.7
2720608C			1/2-14	1.97	7/8	2	.92	25	11.0
2720612C			3/4-14	1.97	1-1/16	2	.92	25	15.6
2720804C	SS		1/4-18	1.86	11/16	2	1.02	25	8.6
2720806C	SS	1/2	3/8-18	1.86	11/16	2	1.02	50 *	7.1
2720808C	SS		1/2-14	2.07	7/8	2	1.02	25 *	11.9
2720812C			3/4-14	2.07	1-1/16	2	1.02	25	16.3
2721006C			3/8-18	2.34	3/4	3	1.50	25	12.0
2721008C		5/8	1/2-14	2.55	7/8	3	1.50	25	14.3
2721012C			3/4-14	2.55	1-1/16	3	1.50	25	19.0
2721208C	SS	3/4	1/2-14	2.55	7/8	3	1.50	25 *	20.0
2721212C	SS		3/4-14	2.55	1-1/16	3	1.50	20 *	19.4
2721612C		1	3/4-14	2.93	1-1/4	3	1.50	10	43.7
2721616C	SS		1 - 11-1/2++	3.11	1-3/8	3	1.50	5 *	49.4

• Add a 'BC' suffix to the part number for the brass cap option. Not available for 5/16" I.D. hose size.

\* 272-SS are packaged to order

\*\* NPT thread on 272-SS

++capped



272W Series

**Yellow Lok-on Cap**

Part Number	Hose ID	Std. Pkg. *
2720400W	1/4	100
2720500W	5/16	100
2720600W	3/8	100
2720800W	1/2	100
2721000W	5/8	50
2721200W	3/4	50
2721600W	1	25

• Sold in full bag quantity only

273 Series

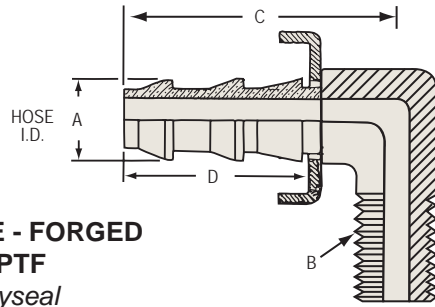

**NPTF - 90° ELBOW MALE - FORGED  
HOSE BARB TO MALE NPTF**

*National Pipe Tapered - Dryseal*

Part Number	Hose ID A	NPTF Thread B	Length Centerline C	No. of Barbs	Barb Length D	Std. Pkg.	Lbs. per 100 pcs.
2730402C	1/4	1/8-27	1.22	2	.82	100	3.7
2730404C		1/4-18	1.40	2	.82	50	6.4
2730602C	3/8	1/8-27	1.35	2	.92	50	4.3
2730604C		1/4-18	1.40	2	.92	50	7.8
2730606C		3/8-18	1.51	2	.92	25	9.5
2730806C	1/2	3/8-18	1.54	2	1.02	25	13.2
2730808C		1/2-14	1.61	2	1.02	25	17.1
2731208C	3/4	1/2-14	2.15	3	1.50	10	25.3
2731212C		3/4-14	2.23	3	1.50	10	28.1

274 Series

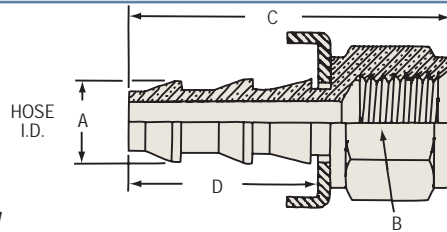

**NPTF-FEMALE  
HOSE BARB**

*National Pipe Tapered - Dryseal*

Part Number	Hose ID A	NPTF Thread B	Length C	Hex	No. of Barbs	Barb Length D	Std. Pkg.	Lbs. per 100 pcs.
2740402C	1/4	1/8-27	1.32	1/2	2	.82	100	2.8
2740404C		1/4-18	1.51	5/8	2	.82	100	4.7
2740406C		3/8-18	1.51	3/4	2	.82	50	5.6
2740502C	5/16	1/8-27	1.32	1/2	2	.82	100	3.4
2740504C		1/4-18	1.51	5/8	2	.82	50	4.9
2740602C	3/8	1/8-27	1.47	9/16	2	.97	50	5.6
2740604C		1/4-18	1.66	5/8	2	.97	50	5.5
2740606C		3/8-18	1.66	3/4	2	.97	50	6.5
2740608C		1/2-14	1.66	15/16	2	.97	50	12.0
2740612C		3/4-14	1.97	1-3/16	2	.97	25	20.0
2740804C		1/4-18	1.76	11/16	2	1.07	50	7.8
2740806C	1/2	3/8-18	1.76	3/4	2	1.07	50	7.4
2740808C		1/2-14	1.76	15/16	2	1.07	25	10.0
2740812C		3/4-14	2.07	1-3/16	2	1.07	25	20.2
2741006C	5/8	3/8-18	2.24	3/4	3	1.55	25	10.0
2741008C		1/2-14	2.24	15/16	3	1.55	25	11.0
2741012C <b>NEW</b>		3/4-14	2.55	1-3/16	3	1.55	25	23.0
2741208C	3/4	1/2-14	2.24	15/16	3	1.55	25	13.7
2741212C		3/4-14	2.55	1-3/16	3	1.55	20	23.5
2741612C		3/4-14	2.55	1-3/16	3	1.55	10	25.5

**Features:**

- easy assembly, no need for ferrules or clamps
- these fittings must be used with Lok-On (push-on style) hose ONLY. 

572 Series

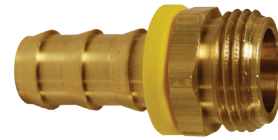
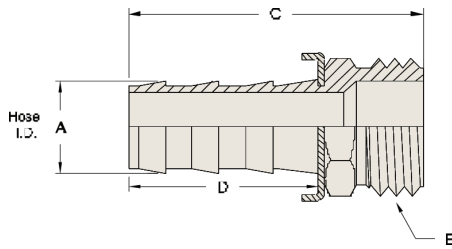

**Lok-On Male Garden Hose Fittings**

Part Number	Hose ID A	NH Thread B	Length C	Hex D	No. of Barbs	Barb Length D	Std. Pkg.	Lbs. per 100 pcs.
5720812C	1/2	3/4-11-1/2	1.83	1-1/16	2	1.02	25	12.3
5721012C	5/8	3/4-11-1/2	2.29	1-1/16	3	1.50	25	14.5
5721212C	3/4	3/4-11-1/2	2.29	1-1/16	3	1.50	25	15.1

574 Series

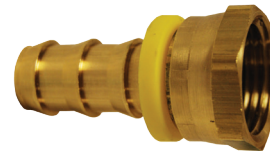
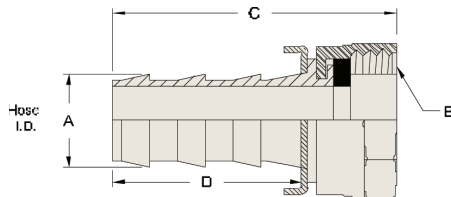

**Lok-On Female Swivel Garden Hose Fittings**

Part Number	Hose ID A	NH Thread B	Length C	Hex D	No. of Barbs	Barb Length D	Std. Pkg.	Lbs. per 100 pcs.
5740812C	1/2	3/4-11-1/2	1.79	1-3/16	2	1.02	25	11.5
5741012C	5/8	3/4-11-1/2	2.25	1-3/16	3	1.50	25	12.2
5741212C	3/4	3/4-11-1/2	2.25	1-3/16	3	1.50	25	13.5

575 Series

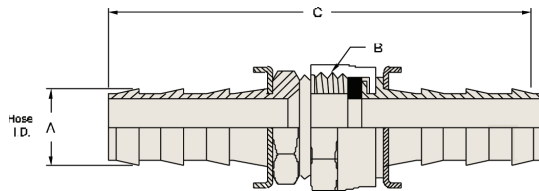

**Lok-On Garden Hose Fitting Set - not assembled**

Part Number	Hose ID A	NH Thread B	Length C	No. of Barbs	Std. Pkg.	Lbs. per 100 pcs.
5750808K	1/2	3/4-11-1/2	3.28	2	25	23.8
5751010K	5/8	3/4-11-1/2	4.23	3	25	26.7
5751212K	3/4	3/4-11-1/2	4.23	3	25	28.6

Lok-on Hose Fittings

278 Series

**NPSM - FEMALE  
SWIVEL HOSE BARB**

National Pipe Straight - Ball Seat Type

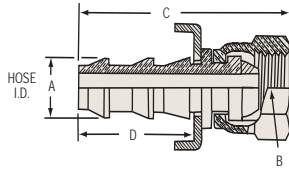

Part Number	Hose ID A	NPSM Thread B	Length C	Hex	No. of Barbs	Barb Length D	Std. Pkg.	Lbs. per 100 pcs.
2780402C		1/8-27	1.39	1/2	2	.77	100	3.1
2780404C	1/4	1/4-18	1.47	11/16	2	.77	50	5.9
2780406C		3/8-18	1.40	11/16	2	.77	50	8.5
2780604C		1/4-18	1.61	11/16	2	.92	50	7.3
2780606C	3/8	3/8-18	1.75	13/16	2	.92	50	9.1
2780608C		1/2-14	1.79	15/16	2	.97	25	10.5
2780808C		1/2-14	1.88	15/16	2	1.02	50	11.7
2780812C	1/2	3/4-14	2.36	1-3/16	2	1.02	25	18.0
2781012C	5/8	3/4-14	2.36	1-3/16	3	1.50	25	19.4
2781212C	3/4	3/4-14	2.36	1-3/16	3	1.50	20	21.3

• Add a 'BC' suffix to the part number for the brass cap option.

280 Series

**NPSM - FEMALE  
SWIVEL HOSE BARB**

National Pipe Straight - Gasket Seat Type

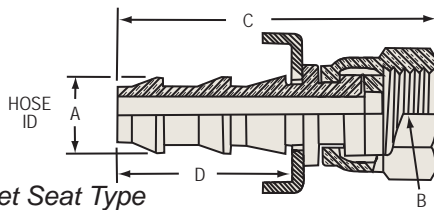

Part Number	Hose ID A	NPSM Thread B	Length C	Hex	No. of Barbs	Barb Length D	Std. Pkg.	Lbs. per 100 pcs.
2800402C	1/4	1/8-27	1.39	1/2	2	.77	100	2.9
2800404C		1/4-18	1.47	11/16	2	.77	100	5.4
2800604C		1/4-18	1.61	11/16	2	.92	50	7.0
2800606C	3/8	3/8-18	1.75	13/16	2	.92	50	8.6
2800608C		1/2-14	1.80	15/16	2	.92	50	9.4
2800808C	1/2	1/2-14	1.88	15/16	2	1.02	25	10.8
2801008C	5/8	1/2-14	2.36	15/16	3	1.50	25	17.8
2801212C	3/4	3/4-14	2.36	1-3/16	3	1.50	20	18.3

• Add a 'BC' suffix to the part number for the brass cap option.  
• **Not recommended for use with water**

282 Series

**MALE HOSE BARB  
45° SAE**

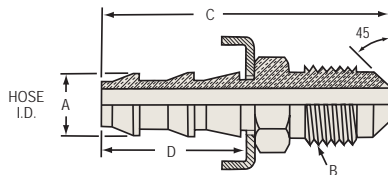

Part Number	Hose ID A	Tube OD	UNF Thread B	Length C	Hex	Number of Barbs	Barb Length D	Std. Pkg.	Lbs. per 100 pcs.
2820407C	1/4	1/4	7/16-20	1.50	7/16	2	.77	100	3.0
2820408C		5/16	1/2-20	1.59	1/2	2	.77	100	4.0
2820610C	3/8	3/8	5/8-18 *	1.83	5/8	2	.92	50	7.4
2820812C	1/2	1/2	3/4-16	2.12	3/4	2	1.02	50	11.5
2821014C	5/8	5/8	7/8-14	2.73	7/8	3	1.50	25	19.4
2821217C	3/4	3/4	1 - 1/16-14 *	2.98	1-1/16	3	1.50	25	32.0



284 Series

**FEMALE SWIVEL HOSE BARB**  
45° SAE

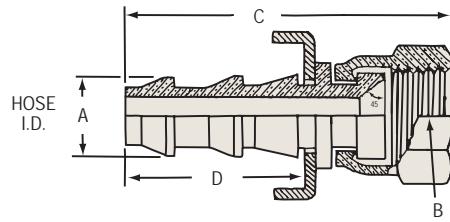

Part Number	Hose ID A	Tube OD	UNF Thread B	Length C	Hex	Number of Barbs	Barb Length D	Std. Pkg.	Lbs. per 100 pcs.
2840410C	1/4	3/8	5/8-18 *	1.60	3/4	2	.77	50	6.6
2840510C	5/16	3/8	5/8-18 *	1.60	3/4	2	.77	50	6.7
2840610C	3/8	3/8	5/8-18 *	1.75	3/4	2	.92	50	7.1
2841217C	3/4	3/4	1 - 1/16-14 *	2.54	1-1/4	3	1.50	10	26.7

\* Notch in nut for SAE identification

• Add a 'BC' suffix to the part number for the brass cap option. Not available for 5/16" I.D. hose size.

286 Series

**MALE HOSE BARB**  
37° JIC

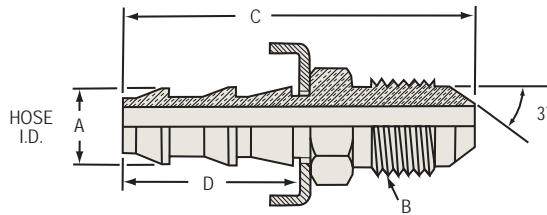

Part Number	Hose ID A	Tube OD	UNF Thread B	Length C	Hex	Number of Barbs	Barb Length D	Std. Pkg.	Lbs. per 100 pcs.
2860407C		1/4	7/16-20	1.59	1/2	2	.77	100	3.4
2860408C	1/4	5/16	1/2-20	1.59	5/8	2	.77	50	4.6
2860409C		3/8	9/16-18	1.63	5/8	2	.77	100	5.1
2860609C	3/8	3/8	9/16-18	1.78	5/8	2	.92	50	5.9
2860812C	1/2	1/2	3/4-16	1.98	7/8	2	1.02	25	11.8
2861014C	5/8	5/8	7/8-14	2.62	15/16	3	1.50	25	18.5
2861217C	3/4	3/4	1 - 1/16-12 *	2.79	1-1/8	3	1.50	10	29.0

\* UN Thread

• Add a 'BC' suffix to the part number for the brass cap option.

287 Series

**FEMALE SWIVEL HOSE BARB**  
45° SAE / 37° JIC (dual angle seat)

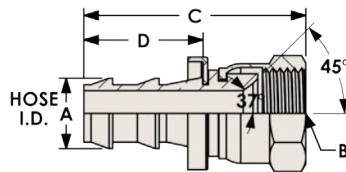

Part Number	303 SS	Hose ID A	Tube OD	UNF Thread B	Length C	Hex	No. of Barbs	Barb Length D	Std. Pkg.	Lbs. per 100 pcs.
2870407C	SS	1/4	1/4	7/16-20	1.50	9/16	2	.77	100 *	3.8
2870408C		5/16	5/16	1/2-20	1.60	5/8	2	.77	100	5.1
2870608C		3/8	5/16	1/2-20	1.75	5/8	2	.92	25	7.1
2870612C		1/2	1/2	3/4-16	1.82	7/8	2	.92	25	9.0
2870812C	SS	1/2	1/2	3/4-16	1.93	7/8	2	1.02	25 *	10.7
2870814C		5/8	5/8	7/8-14	1.99	1	2	1.02	25	12.8
2871014C		5/8	5/8	7/8-14	2.47	1	3	1.50	25	17.4
2871214C		3/4	5/8	7/8-14	2.47	1	3	1.50	25	24

Lok-on Hose Fittings

288 Series

**FEMALE SWIVEL HOSE BARB**  
37°

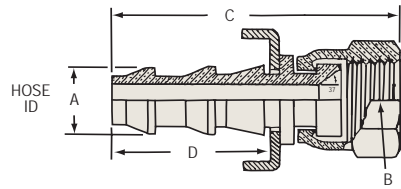

Part Number	303 SS	Hose ID A	Tube OD	UNF Thread B	Length C	Hex	No. of Barbs	Barb Length D	Std. Pkg.	Lbs. per 100 pcs.
2880409C		1/4	3/8	9/16-18	1.60	11/16	2	.77	50	5.3
2880509C		5/16	3/8	9/16-18	1.60	11/16	2	.82	50	5.8
2880609C	SS	3/8	3/8	9/16-18	1.75	11/16	2	.92	50 *	6.5
2880809C		1/2	3/8	9/16-18	1.85	11/16	2	1.02	25	9.4
2881217C	SS	3/4	3/4	1 - 1/16-12 **	2.53	1-1/4	3	1.50	10 *	25.9
2881621C	SS	1	1	1 - 5/16-12 **	2.67	1-7/16	3	1.50	10 *	32.5

• Add a 'BC' suffix to the part number for the brass cap option. Not available for 5/16" I.D. hose size.

\* 288-SS are packaged to order

\*\* UN Thread

289 Series

**FEMALE SWIVEL 90° ELBOW**  
37° JIC / 45° SAE - PLATED STEEL

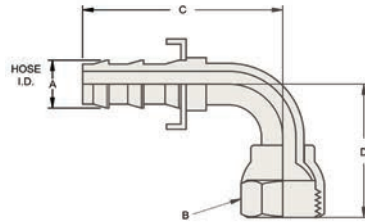

Part Number	Hose ID A	Tube OD	UNF Thread B	Length Centerline C	Length Centerline D	No. of Barbs	Std. Pkg.	Lbs. per 100 pcs.
2890407C +	1/4	1/4	7/16-20	1.55	.83	2	25	5.6
2890407CSAE *		1/4	7/16-20	1.60	.83	2	25	6.4
2890609C +	3/8	3/8	9/16-18	1.85	.91	2	25	10.0
2890610CSAE *		3/8	5/8-18	1.98	.85	2	25	11.2
2890812C +	1/2	1/2	3/4-16	2.33	1.09	2	10	18.1
2891217C +	3/4	3/4	1 - 1/16-12 **	3.26	1.81	3	5	40.0

\* Notch in nut for SAE identification

\*\* UN Thread

+ JIC only, may substitute dual angle

290 Series

**SAE INVERTED FLARE MALE SWIVEL HOSE BARB**

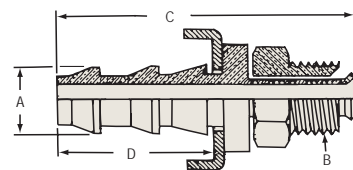

Part Number	Hose ID A	Tube OD	UNF Thread B	Length C	Hex	Number of Barbs	Barb Length D	Std. Pkg.	Lbs. per 100 pcs.
2900406C	1/4	3/16	3/8-24	1.52	7/16	2	.77	100	3.2
2900407C		1/4	7/16-24 *	1.52	7/16	2	.77	100	3.1
2900408C		5/16	1/2-20	1.58	1/2	2	.77	100	3.8
2900508C	5/16	5/16	1/2-20	1.58	1/2	2	.77	50	4.1
2900510C		3/8	5/8-18	1.63	5/8	2	.77	50	6.1
2900608C	3/8	5/16	1/2-20	1.73	1/2	2	.92	100	5.8
2900610C		3/8	5/8-18	1.78	5/8	2	.92	50	7.0
2900812C	1/2	1/2	3/4-18 *	1.96	3/4	2	1.02	50	10.5
2901014C	5/8	5/8	7/8-18 *	2.50	7/8	3	1.50	25	14.9

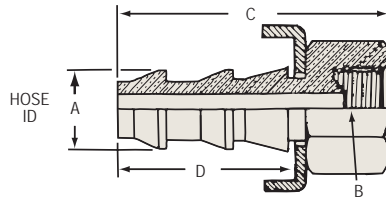

**SAE INVERTED FLARE  
RIGID FEMALE HOSE BARB**

Part Number	Hose ID A	Tube OD	UNF Thread B	Length C	Hex	Number of Barbs	Barb Length D	Std. Pkg.	Lbs. per 100 pcs.
2920406C		3/16	3/8-24	1.17	7/16	2	.77	100	2.3
2920407C	1/4	1/4	7/16-24 *	1.16	1/2	2	.77	100	2.1
2920408C		5/16	1/2-20	1.19	9/16	2	.77	100	2.7
2920508C	5/16	5/16	1/2-20	1.19	9/16	2	.77	100	3.9
2920608C	3/8	5/16	1/2-20	1.34	9/16	2	.92	100	4.4
2920610C	3/8	3/8	5/8-18	1.39	3/4	2	.92	50	5.4
2920812C	1/2	1/2	3/4-18 *	1.54	7/8	2	1.02	25	7.8

- \* UNS Thread
- Add a 'BC' suffix to the part number for the brass cap option.

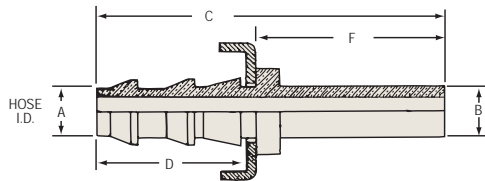

**RIGID TUBE SHANK  
HOSE BARB**

Part Number	303 SS	Hose ID A	Tube OD B	Length C	Tube Length F	No. of Barbs	Barb Length D	Std. Pkg.	Lbs. per 100 pcs.
2940403C			3/16	1.68	.86	2	.77	100	1.9
2940404C	SS	1/4	1/4	1.88	1.06	2	.77	100 *	1.8
2940405C			5/16	1.88	1.06	2	.77	100	2.6
2940606C	SS	3/8	3/8	2.03	1.06	2	.92	50 *	3.5
2940808C	SS	1/2	1/2	2.13	1.06	2	1.02	50 *	5.9
2941010C		5/8	5/8	2.61	1.06	3	1.50	25	9.7
2941212C	SS	3/4	3/4	2.61	1.06	3	1.50	25 *	25.3

- \* 294-SS packaged to order
- Add a 'BC' suffix to the part number for the brass cap option.

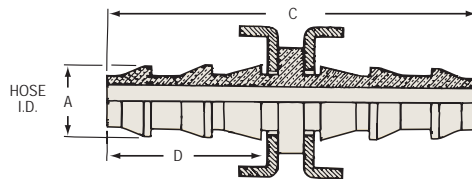

**HOSE SPLICER**

Part Number	303 SS	Hose ID A	Length C	No. of Barbs	Barb Length D	Barb Std. Pkg.	Lbs. per 100 pcs.
2960404C	SS	1/4	1.73	2	.77	100 *	2.5
2960505C		5/16	1.73	2	.77	100	3.4
2960606C	SS	3/8	2.05	2	.92	50 *	7.5
2960808C	SS	1/2	2.25	2	1.02	50 *	7.5
2961010C		5/8	3.21	3	1.50	20	12.4
2961212C		3/4	3.21	3	1.50	15	15.4
2961616C		1	3.21	3	1.50	10	28.7

- Add a 'BC' suffix to the part number for the brass cap option. Not available for 5/16" I.D. hose size.



**Call Toll Free: 1-866-711-4673  
International: +1-727-342-5086**



# Brass Pipe Fittings

## 163 Series

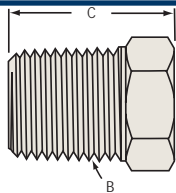

### HEX HEAD PLUG

NPT- Part is hollow

Part Number	NPT Thread B	Overall Length C	Hex	Std. Pkg.	Lbs. per 100 pcs.
1630200C	1/8-27	.56	7/16	50	1.7
1630400C	1/4-18	.63	9/16	100	3.4
1630600C	3/8-18	.78	11/16	25	5.1
1630800C	1/2-14	.97	7/8	25	8.0
1631200C	3/4-14	1.06	1-1/16	25	14.1
1631600C	1 - 11-1/2	1.35	1-3/8	10	28.0

## 165 Series

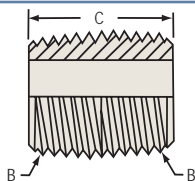

### CLOSE PIPE NIPPLE

NPT

Part Number	NPT Thread B	Length C	Flow Diameter	Std. Pkg.	Lbs. per 100 pcs.
1650202C	1/8-27	.75	.250	50	1.0
1650404C	1/4-18	.88	.375	50	2.0
1650606C	3/8-18	1.00	.500	100	3.4
1650808C	1/2-14	1.12	.625	25	5.5
1651212C	3/4-14	1.31	.750	25	11.3
1651616C	1 - 11-1/2	1.75	.935	25	15.6

## 166 Series

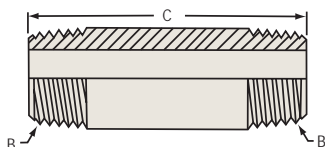

### LONG PIPE NIPPLE

NPT

Part Number	NPT Thread B	Length C	Flow Diameter	Std. Pkg.	Lbs. per 100 pcs.
1660215C	1/8-27	1.50	.256	25	2.6
1660220C		2.00	.250	25	3.8
1660225C		2.50	.250	25	4.9
1660230C		3.00	.256	25	6.8
1660235C		3.50	.256	10	6.9
1660240C		4.00	.256	10	7.7
1660415C	1/4-18	1.50	.375	25	4.4
1660420C		2.00	.375	25	5.9
1660425C		2.50	.375	25	8.4
1660430C		3.00	.375	25	10.1
1660435C		3.50	.375	10	11.9
1660440C		4.00	.375	10	13.7
1660450C		5.00	.375	5	17.6
1660615C		3/8-18	1.50	.500	25
1660620C	2.00		.500	25	8.7
1660625C	2.50		.500	10	11.7
1660630C	3.00		.500	10	14.0
1660635C	3.50		.500	10	16.6
1660640C	4.00		.500	5	19.2

166 Series

**LONG PIPE NIPPLE**  
NPT (continued)

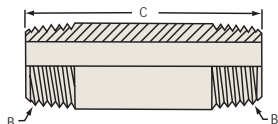

Part Number	NPT Thread B	Length C	Flow Diameter	Std. Pkg.	Lbs. per 100 pcs.
1660815C	1/2-14	1.50	.625	10	9.4
1660820C		2.00	.625	10	12.7
1660825C		2.50	.625	10	16.3
1660830C		3.00	.625	10	20.2
1660835C		3.50	.625	10	23.8
1660840C		4.00	.625	5	27.6
1661220C	3/4-14	2.00	.840	5	17.9
1661225C		2.50	.840	5	23.1
1661230C		3.00	.840	5	28.0
1661235C		3.50	.840	5	32.9

• The last two digits of the part number represent the overall length.

169 Series

**90° MALE PIPE ELBOW- Forged**  
NPTF - Dryseal

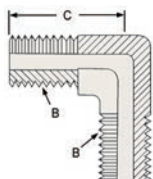

Part Number	NPTF Thread B	Length Centerline C	Std. Pkg.	Lbs. per 100 pcs.
1690202C	1/8-27	.70	25	3.7
1690404C	1/4-18	.83	25	6.6
1690606C	3/8-18	.94	25	8.7
1690808C	1/2-14	1.10	25	16.5

172 Series

**MALE UNION**  
NPSM to NPTF

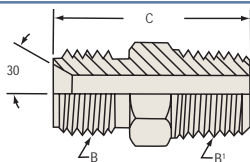

Part Number	NPSM Thread B	NPTF Thread B'	Length C	Hex	Std. Pkg.	Lbs. per 100 pcs.
1720202C	1/8	1/8-27	.94	7/16	100	2.5
1720402C	1/4	1/8-27	1.06	9/16	100	3.9
1720404C		1/4-18	1.25	9/16	100	5.1
1720604C	3/8	1/4-18	1.28	11/16	100	6.5
1720606C		3/8-18	1.30	11/16	50	8.1
1720608C		1/2-14	1.47	7/8	50	13.0
1720806C	1/2	3/8-18	1.35	7/8	50	10.5
1720808C		1/2-14	1.53	7/8	50	13.1
1721212C	3/4	3/4-14	1.53	1-1/16	25	18.8

174 Series

**ADAPTER**  
NPSM to NPTF

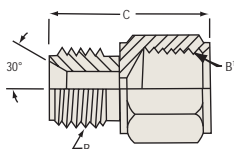

Part Number	NPSM Thread B	NPTF Thread B'	Length C	Hex	Std. Pkg.	Lbs. per 100 pcs.
1740404C	1/4	1/4	1.12	5/8	100	5.6
1740606C	3/8	3/8	1.15	9/16	50	8.0

176 Series

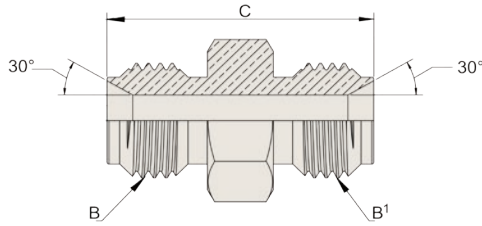

**MALE UNION**  
NPSM to NPSM

Part Number	NPSM Thread B	NPSM Thread B'	Length C	Hex	Std. Pkg.	Lbs. per 100 pcs.
1760202C	1/8	1/8	.79	7/16	100	2.0
1760404C	1/4	1/4	1.09	9/16	100	4.2
1760606C	3/8	3/8	1.19	11/16	100	7.2
1760808C	1/2	1/2	1.31	7/8	50	10.4

207BH Series

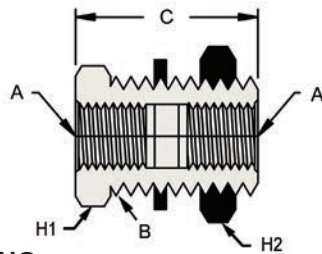

**BULKHEAD ANCHOR COUPLING**  
Washer Nut is 12L14 Steel

Part Number	NPTF Pipe Thread A	UNS Straight Thread B	Hex H1	Hex H2	Length C	Std. Pkg.	Lbs. per 100 pcs.
207BH2	1/8-27	5/8-18	7/8	15/16	1.50	25	16.3
207BH4	1/4-18	3/4-16	1	1	1.50	25	19.4
207BH4S		3/4-16	1	1	.94	25	15.0
207BH6	3/8-18	1-14	1-1/8	1-1/4	1.31	10	27.5
207BH8	1/2-14	1-1/8-14	1-1/4	1-3/8	1.50	10	33.1
207BH12	3/4-14	1-5/16-12	1-1/2	1-1/2	1.50	10	41.3

211 Series

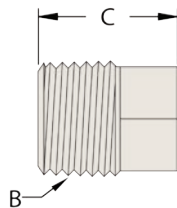

**SQUARE HEAD PLUG**  
PTF-SAE Short- Lead Free per NSF/ANSI 372

Part Number	PTF-SAE Thread B	Length C	Square	Std. Pkg.	Lbs. per 100 pcs.
2110200C	1/8-27	.59	9/32	50	2.0
2110400C	1/4-18	.80	3/8	100	3.0
2110600C	3/8-18	.83	7/16	25	6.0
2110800C	1/2-14	1.07	9/16	25	13.0
2111200C	3/4-14	1.14	5/8	25	20.0

**PIPE CAP**  
NPT

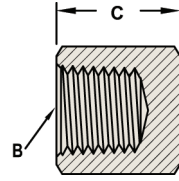

Part Number	NPT Thread B	Length C	Hex	Std. Pkg.	Lbs. per 100 pcs.
2130200C	1/8-27	.50	9/16	50	3.0
2130400C <sup>1</sup>	1/4-18	.63	5/8	100	4.0
2130600C <sup>1</sup>	3/8-18	.63	13/16	25	6.0
2130800C <sup>1</sup>	1/2-14	.87	1	25	8.0
2131200C	3/4-14	.89	1-3/16	25	16.0

<sup>1</sup> Lead Free per NSF/ANSI 372

**HEX SOCKET PLUG**

NPTF - Lead Free per NSF/ANSI 372



Part Number	NPTF Thread B	Length C	Hex	Std. Pkg.	Lbs. per 100 pcs.
2190200C	1/8-27	.30	3/16	50	1.0
2190400C	1/4-18	.46	1/4	100	2.0
2190600C	3/8-18	.46	5/16	25	3.0
2190800C	1/2-14	.61	3/8	25	5.0
2191200C	3/4-14	.62	9/16	25	10.0

**FEMALE PIPE CROSS- Extruded**

NPTF - Dryseal

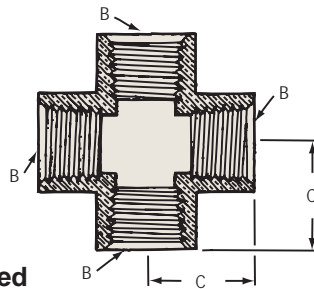

Part Number	NPTF Thread B	C	Std. Pkg.	Lbs. per 100 pcs.
2280202C	1/8-27	.57	25	9.6
2280404C	1/4-18	.78	25	19.5
2280606C	3/8-18	.84	25	26.7
2280808C	1/2-14	1.07	10	54.2
2281212C	3/4-14	1.46	10	79.4



**Call Toll Free: 1-866-711-4673**  
**International: +1-727-342-5086**



302 Series

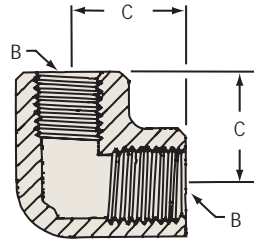

**90° FEMALE PIPE ELBOW- Extruded**  
NPTF - Dryseal  
Ref. SAE 130238

Part Number	NPTF Thread B	C	Std. Pkg.	Lbs. per 100 pcs.
3020202C	1/8-27	.55	25	6.3
3020404C	1/4-18	.78	25	14.8
3020606C	3/8-18	.84	25	20.0
3020808C	1/2-14	1.09	25	38.6
3021212C	3/4-14	1.16	10	58.1

304 Series

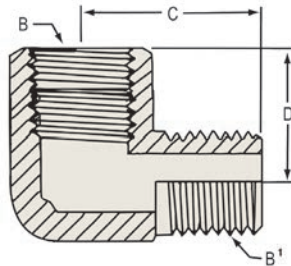

**FULL PATTERN 90° STREET ELBOW- Extruded**  
NPTF - Dryseal  
Ref. SAE 130239

Part Number	NPTF Thread B	NPTF Thread B'	C	D	Std. Pkg.	Lbs. per 100 pcs.
3040202C	1/8-27	1/8-27	.66	.48	25	4.9
3040402C	1/4-18	1/8-27	.72	.45	25	11.3
3040404C	1/4-18	1/4-18	.91	.72	25	12.0
3040604C	3/8-18	1/4-18	1.25	.78	25	14.4
3040606C	3/8-18	3/8-18	.97	.78	25	16.4
3040806C	1/2-14	3/8-18	1.25	.97	25	32.3
3040808C	1/2-14	1/2-14	1.24	1.09	25	37.3
3041208C	3/4-14	1/2-14	1.39	1.10	25	50.3
3041212C	3/4-14	3/4-14	1.38	1.12	10	51.9

306 Series

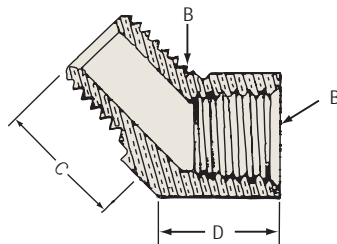

**45° STREET ELBOW- Extruded**  
NPTF - Dryseal  
Ref. SAE 130339

Part Number	NPTF Thread B	C	D	Std. Pkg.	Lbs. per 100 pcs.
3060202C	1/8-27	.50	.38	25	3.7
3060404C	1/4-18	.72	.56	25	7.6
3060606C	3/8-18	.72	.56	25	11.9
3060808C	1/2-14	1.00	.75	25	25.8



**FEMALE PIPE TEE- Extruded**  
*NPTF - Dryseal*  
 Ref. SAE 130438

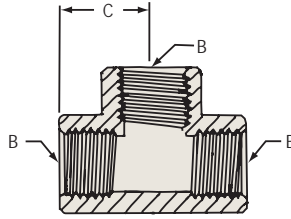

Part Number	NPTF Thread B	C	Std. Pkg.	Lbs. per 100 pcs.
3220202C	1/8-27	.55	25	7.7
3220404C	1/4-18	.78	25	19.1
3220606C	3/8-18	.84	25	23.2
3220808C	1/2-14	1.09	25	47.1
3221212C	3/4-14	1.16	10	65.3

**MALE BRANCH TEE- Extruded**  
*NPTF - Dryseal*  
 Ref. SAE 130425

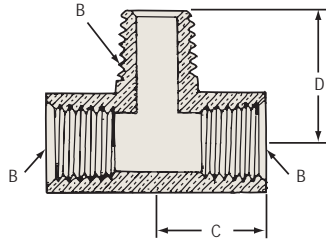

Part Number	NPTF Thread B	C	D	Std. Pkg.	Lbs. per 100 pcs.
3240202C	1/8-27	.55	.66	25	6.4
3240404C	1/4-18	.78	.91	25	16.1
3240606C	3/8-18	.84	.97	25	22.3
3240808C	1/2-14	1.09	1.25	25	42.4
3241212C	3/4-14	1.09	1.25	10	58.0

**STREET TEE- Extruded**  
*NPTF - Dryseal*  
 Ref. SAE 130424

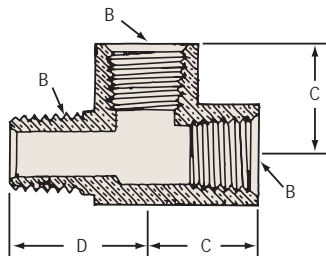

Part Number	NPTF Thread B	C	D	Std. Pkg.	Lbs. per 100 pcs.
3260202C	1/8-27	.55	.73	25	6.3
3260404C	1/4-18	.78	.91	25	15.8
3260606C	3/8-18	.84	.97	25	21.6
3260808C	1/2-14	1.09	1.28	25	44.3
3261212C	3/4-14	1.09	1.38	10	59.1



**Call Toll Free: 1-866-711-4673**  
**International: +1-727-342-5086**



370 Series

**MALE HEX NIPPLE**

*NPTF - Dryseal*  
*Ref. SAE 130137*

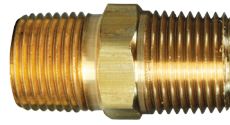
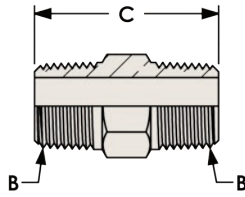

Part Number	NPTF Thread B	Length C	Hex	Std. Pkg.	Lbs. per 100 pcs.
3700202C	1/8-27	.97	7/16	100	2.5
3700404C	1/4-18	1.38	9/16	100	5.4
3700606C	3/8-18	1.41	11/16	50	7.7
3700808C	1/2-14	1.81	7/8	25	14.4
3701212C	3/4-14	1.75	1-1/16	20	21.4
3701616C	1 - 11-1/2	2.24	1-3/8	10	40.0

371 Series

**FEMALE HEX COUPLING**

*NPTF - Dryseal*  
*Ref. SAE 130138*

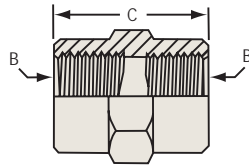

Part Number	NPTF Thread B	Length C	Hex	Std. Pkg.	Lbs. per 100 pcs.
3710202C	1/8-27	.75	9/16	25	3.3
3710404C	1/4-18	1.12	3/4	25	8.8
3710606C	3/8-18	1.12	7/8	25	10.4
3710808C	1/2-14	1.50	1-1/16	25	19.9
3711212C	3/4-14	1.57	1-3/8	10	37.2

373 Series

**REDUCER BUSHING**

*NPTF - Dryseal*  
*Ref. SAE 130140*

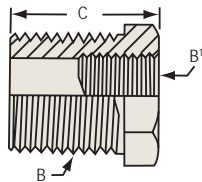

Part Number	NPTF Thread B External	NPTF Thread B' Internal	Length C	Hex	Std. Pkg.	Lbs. per 100 pcs.	
3730402C	1/4-18	1/8-27	.75	9/16	100	2.6	
3730602C	3/8-18	1/8-27	.75	11/16	100	5.3	
3730604C		1/4-18	.75	3/4	100	4.0	
3730802C	1/2-14	1/8-27	1.00	7/8	25	12.9	
3730804C		1/4-18	1.00	7/8	50	10.4	
3730806C		3/8-18	1.00	7/8	50	7.3	
3731202C *	3/4-14	1/8-27	.94	1-1/16	25	21.6	
3731204C		1/4-18	1.00	1-1/8	25	20.5	
3731206C		3/8-18	1.00	1.00	1-1/8	25	22.1
3731208C		1/2-14	1.00	1.00	1-1/8	25	12.5
3731604C *	1-11-1/2	1/4-18	1.12	1-3/8	10	48.7	
3731606C *		3/8-18	1.12	1-7/16	10	43.7	
3731608C		1/2-14	1.12	1.12	1-7/16	10	37.2

**ADAPTER**  
NPTF - Dryseal  
Ref. SAE 130139

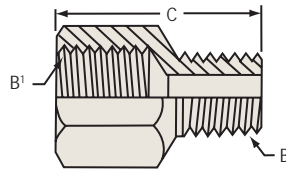

Part Number	NPTF Thread B' Internal	NPTF Thread B External	Length C	Hex	Std. Pkg.	Lbs. per 100 pcs.
3750202C	1/8-27	1/8-27	.88	9/16	100	3.6
3750402C	1/4-18	1/8-27	1.06	3/4	50	7.3
3750404C		1/4-18	1.25	3/4	50	8.8
3750602C	3/8-18	1/8-27	1.07	7/8	50	7.4
3750604C		1/4-18	1.25	7/8	50	10.2
3750606C		3/8-18	1.25	7/8	50	10.6
3750804C	1/2-14	1/4-18	1.47	1-1/16	25	9.8
3750806C		3/8-18	1.47	1-1/16	25	18.3
3750808C		1/2-14	1.66	1-1/16	25	20.6
3751206C	3/4-14	3/8-18	1.50	1-3/8	10	18.0
3751208C		1/2-14	1.69	1-3/8	10	33.2
3751212C		3/4-14	1.69	1-3/8	10	34.3

**REDUCER COUPLER**  
NPTF - Dryseal (double female)  
Ref. SAE 130138

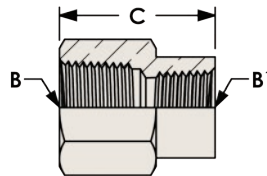

Part Number	NPTF Thread B	NPTF Thread B'	Length C	Hex	Std. Pkg.	Lbs. per 100 pcs.
3770402C	1/4-18	1/8-27	.97	3/4	50	7.5
3770602C	3/8-18	1/8-27	1.00	7/8	50	5.7
3770604C		1/4-18	1.16	7/8	50	11.6
3770804C	1/2-14	1/4-18	1.28	1-1/16	25	13.3
3770806C		3/8-18	1.38	1-1/16	10	20.1
3771206C	3/4-14	3/8-18	1.38	1-3/8	10	18.4
3771208C		1/2-14	1.50	1-3/8	10	23.1

**MALE REDUCING HEX NIPPLE**  
NPTF - Dryseal  
Ref. SAE 130137

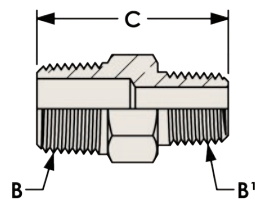

Part Number	NPTF Thread B	NPTF Thread B'	Length C	Hex	Std. Pkg.	Lbs. per 100 pcs.
3790402C	1/4-18	1/8-27	1.19	9/16	100	4.5
3790602C	3/8-18	1/8-27	1.22	11/16	50	6.3
3790604C		1/4-18	1.41	11/16	50	7.4
3790804C	1/2-14	1/4-18	1.62	7/8	50	10.5
3790806C		3/8-18	1.62	7/8	50	12.3

# Garden Hose Fittings and Accessories

## 500 Series



### ACCESSORIES - BAR STOCK

Part Number	Description
500BFP	back flow preventer

#### Features:

- 125 max PSI
- Working Temperature 33°F - 140°F
- EPDM gasket
- Stainless steel components

### NOZZLES

Part Number	Description
500AN4	4" adjustable nozzle
500AN7	6" adjustable nozzle
500SN2	2" sweeper nozzle, machined brass
500SN6	6" sweeper nozzle, machined brass

### ACCESSORIES- Forged

Part Number	Description
500GHV	Forged brass ball valve, 3/4 NH male x female; 140°F - 100 PSI
500GHY	Double Y valve, swivel inlet - with Higbie cut threads (capped) to prevent cross threading; 140°F - 100 PSI
500YC	Y coupler, nickel plated brass; 195°F - 150 PSI
500GH4VBK	GH 4 valve manifold, swivel inlet, black knob; 120°F - 100 PSI

### COUPLERS

Part Number	303 SS	Description
500QCF	SS	Female coupler; 140°F - 150 PSI
500QCSG		Garden hose coupler seal gasket: NBR material, 140°F - 150 PSI
500QCFV		Valved coupler, water shutoff; 140°F - 150 PSI
500QCM	SS	Male plug, extended thread; 195°F - 150 PSI
500QCK	SS	Complete assembly; 140°F - 150 PSI
500QCKV		Complete assembly, valved; 140°F - 150 PSI

### COMPONENTS

Part Number	Description
5911212F	Filter Washer, 1.00" OD, 304 stainless steel mesh, FDA black PVC duro, 70A
5911212W	Washer, .63" ID, 1.00" OD black 80 duro SBR
5911616W	Washer, .86" ID, 1.27" OD black 60 duro SBR
5861012N	3/4" Garden hose nut round with knurl
5911212N	3/4" Garden hose nut hex with knurl
5911616N	1" Garden hose nut (NPSH) hex with knurl

Note: Hose fittings stem components are also available separately. Contact Diver Bros for availability and pricing.

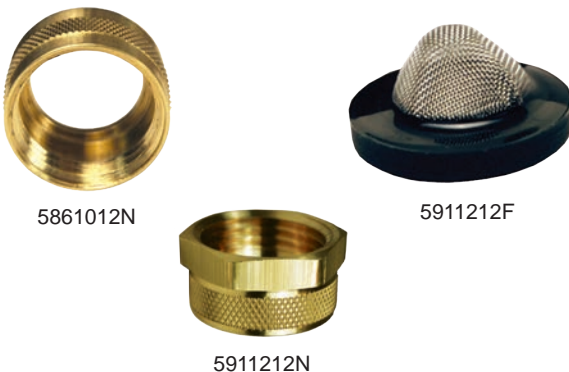

Garden Hose Fittings



303 Stainless Steel

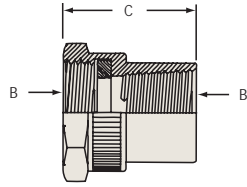

CDA Brass 360

501 Series

**FEMALE HOSE x FEMALE PIPE**

*Non-swivel NH x NPTF*

Part Number	303 SS	NH Thread B	NPTF Thread B <sup>1</sup>	Length C	Hex	Std. Pkg.	Lbs. per 100 pcs.
5011202C		3/4 - 11-1/2	1/8-27	1.02	1-3/16	50	9.9
5011204C			1/4-18	1.12	1-3/16	25	10.4
5011206C			3/8-18	1.18	1-3/16	25	10.6
5011208C	SS	3/4 - 11-1/2	1/2-14	1.32	1-3/16	25 *	12.4
5011212C	SS		3/4-14	1.56	1-3/16	25 *	13.0

\* 501-SS threads B<sup>1</sup> are NPT and the parts are packaged to order



303 Stainless Steel

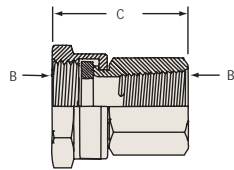

CDA Brass 360

502 Series

**FEMALE HOSE x FEMALE PIPE**

*Swivel NH x NPTF*

Part Number	303 SS	NH Thread B	NPTF Thread B <sup>1</sup>	Length C	Hex	Std. Pkg.	Lbs. per 100 pcs.
5021208C	SS	3/4 - 11-1/2	1/2-14	1.33	1-3/16	25 *	15.4
5021212C	SS		3/4-14	1.59	1-3/16	10 *	22.3

\* 502-SS threads B<sup>1</sup> are NPT and the parts are packaged to order



303 Stainless Steel

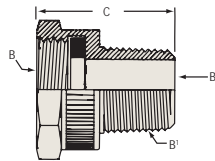

CDA Brass 360

503 Series

**FEMALE HOSE x MALE PIPE**

*Non-swivel NH x NPTF*

Part Number	303 SS	NH Thread B	NPTF Thread B <sup>1</sup>	NPTF Thread B <sup>2</sup>	Length C	Hex	Std. Pkg.	Lbs. per 100 pcs.
5031206C		3/4 - 11-1/2	3/8-18	---	1.37	1-3/16	25	11.3
5031208C				---	1.37	1-3/16	25 *	13.0
5031212C				---	1.37	1-3/16	25 *	14.0

\* 503-SS threads B<sup>1</sup> are NPT and the parts are packaged to order



303 Stainless Steel

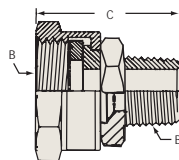

CDA Brass 360

504 Series

**FEMALE HOSE x MALE PIPE**

*Swivel - Internal and External Hex NH x NPTF*

Part Number	303 SS	NH Thread B	NPTF Thread B <sup>1</sup>	Length C	Hex	Std. Pkg.	Lbs. per 100 pcs.
5041204C		3/4 - 11-1/2	1/4-18	1.43	1-3/16	25	12.5
5041206C			3/8-18	1.43	1-3/16	25	15.1
5041208C			1/2-14	1.63	1-3/16	25 *	16.3

506 Series

**FEMALE HOSE x FEMALE HOSE**

*Swivel NH x NH*

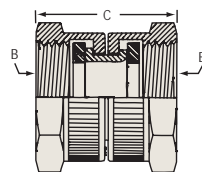

Part Number	NH Thread B	Length C	Hex	Std. Pkg.	Lbs. per 100 pcs.
5061212C	3/4 - 11-1/2	1.32	1-3/16	25	14.1

507 Series

**MALE HOSE x FEMALE PIPE**

*NH x NPTF*



303 Stainless Steel

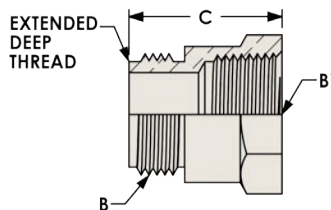

CDA Brass 360

Part Number	303 SS	NH Thread B	NPTF Thread B'	Length C	Hex	Std. Pkg.	Lbs. per 100 pcs.
5071204C		3/4 - 11-1/2	1/4-18	.75	1-1/16	25	13.6
5071206C			3/8-18	.75	1-1/16	25	11.1
5071208C	SS		1/2-14	.75	1-1/16	25 *	7.9
5071212C	SS		3/4-14	1.37	1-3/16	25 *	20.0

\* 507-SS threads B' are NPT and the parts are packaged to order

508 Series

**MALE HOSE x MALE PIPE**

*NH x NPTF*



303 Stainless Steel

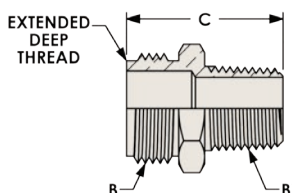

CDA Brass 360

Part Number	303 SS	NH Thread B	NPTF Thread B'	Length C	Hex	Std. Pkg.	Lbs. per 100 pcs.
5081206C		3/4 - 11-1/2	3/8-18	1.31	1-1/16	25	11.9
5081208C	SS		1/2-14	1.50	1-1/16	25 *	13.5
5081212C	SS		3/4-14	1.50	1-1/16	25 *	16.7
5081216C			1 - 11-1/2	1.85	1-3/8	10	22.5

\* 508-SS threads B' are NPT and the parts are packaged to order

509 Series

**MALE HOSE x MALE HOSE**

*NH x NH*



303 Stainless Steel

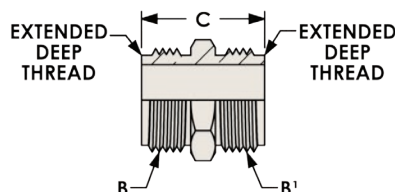

CDA Brass 360

Part Number	303 SS	NH Thread B	NH Thread B'	Length C	Hex	Std. Pkg.	Lbs. per 100 pcs.
5091212C	SS	3/4 - 11-1/2	3/4 - 11-1/2	1.24	1-1/16	25 *	13.1
5091612C		1 - 11-1/2 **	3/4 - 11-1/2	1.43	1-3/8	20	18.9

\* 509-SS are packaged to order

**HOSE CAP**  
Round

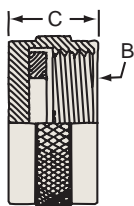

Part Number	NH Thread B	Length C	Std. Pkg.	Lbs. per 100 pcs.
5131212C	3/4 - 11-1/2	.625	25	7.8



303 Stainless Steel

**MALE HOSE x MALE PIPE x  
FEMALE PIPE**  
NH x NPTF x NPTF

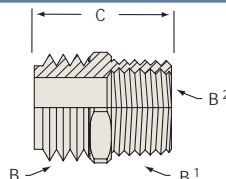

CDA Brass 360

Part Number	303 SS	NH Thread B	NPTF Thread B <sup>1</sup>	NPTF Thread B <sup>2</sup>	Length C	Hex	Std. Pkg.	Lbs. per 100 pcs.
5141212C	SS	3/4 - 11-1/2	3/4-14	1/2-14	1.50	1-1/16	25*	16

\* 514-SS threads are NPT and the parts are packaged to order

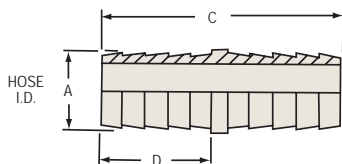

**GARDEN HOSE MENDER**

Part Number	Hose ID A	Length C	No. of Barbs	Barb Length D	Std. Pkg.	Lbs. per 100 pcs.
5780808C	1/2	2.06	4	.97	50	6.5
5781010C	5/8	2.06	4	.97	50	8.6
5781212C	3/4	2.50	4	1.19	20	12.9
5781616C	1	3.00	5	1.44	10	22.5

Note: See page 8 for stainless steel menders

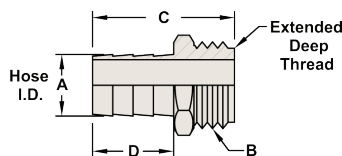

**SHORT SHANK  
MALE GARDEN HOSE FITTING**

Part Number	Hose ID A	NH Thread B	Length C	Hex	No. of Barbs	Barb Length D	Std. Pkg.	Lbs. per 100 pcs.
5850812C	1/2	3/4 - 11-1/2	1.75	1-1/16	3	1.00	25	11.0
5851012C	5/8	3/4 - 11-1/2	1.75	1-1/16	3	1.00	25	11.9

586 Series

**SHORT SHANK FEMALE SWIVEL GARDEN HOSE FITTING**  
(round nut)

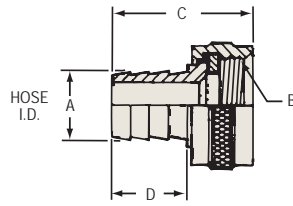

Part Number	Hose ID A	NH Thread B	Length C	No. of Barbs	Barb Length D	Std. Pkg.	Lbs. per 100 pcs.
5860812C	1/2	3/4 - 11-1/2	1.63	3	1.00	25	9.8
5861012C	5/8	3/4 - 11-1/2	1.63	3	1.00	25	10.2
5861212C	3/4	3/4 - 11-1/2	1.63	3	1.00	25	11.5

587 Series

**SHORT SHANK GARDEN HOSE FITTING SET \***  
(round nut)

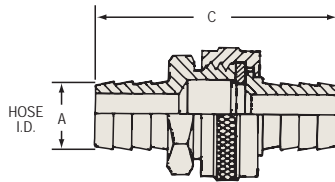

Part Number	Hose ID A	NH Thread B	Length C	No. of Barbs	Std. Pkg.	Lbs. per 100 pcs.
5870808K	1/2	3/4 - 11-1/2	2.95	3	25	20.8
5871010K	5/8	3/4 - 11-1/2	2.95	3	25	22.1
5871212K	3/4	3/4 - 11-1/2	2.95	3	25	25.0

\* not assembled

588 Series

**SHORT SHANK FEMALE SWIVEL GARDEN HOSE FITTING**  
(hex nut)

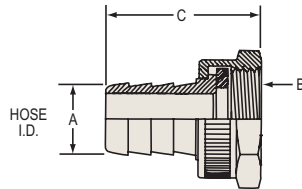

Part Number	Hose ID A	NH Thread B	Length C	No. of Barbs	Barb Length D	Std. Pkg.	Lbs. per 100 pcs.
5880812C	1/2	3/4 - 11-1/2	1.63	3	1.00	25	10.7
5881012C	5/8	3/4 - 11-1/2	1.63	3	1.00	25	10.9
5881212C	3/4	3/4 - 11-1/2	1.63	3	1.00	25	12.1

589 Series

**SHORT SHANK GARDEN HOSE FITTING SET \***  
(hex nut)

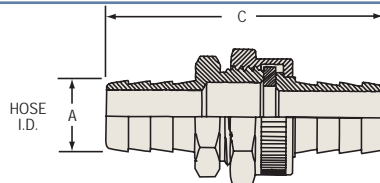

Part Number	Hose ID A (both fittings)	NH Thread B	Length C	No. of Barbs	Std. Pkg.	Lbs. per 100 pcs.
5890808K	1/2	3/4 - 11-1/2	2.95	3	25	21.7
5891010K	5/8	3/4 - 11-1/2	2.95	3	25	22.9
5891212K	3/4	3/4 - 11-1/2	2.95	3	25	25.6

\* not assembled



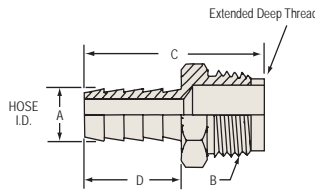

**MALE GARDEN HOSE FITTING**

Part Number	303 SS	Hose ID A	NH Thread B	Length C	Hex	No. of Barbs	Barb Length D	Std. Pkg.	Lbs. per 100 pcs.
5900612C		3/8	3/4 - 11-1/2	1.94	1-1/16	4	1.19	25	11.3
5900812C	SS	1/2	3/4 - 11-1/2	1.94	1-1/16	4	1.19	25 *	12.3
5901012C	SS	5/8	3/4 - 11-1/2	1.94	1-1/16	4	1.19	25 *	14.5
5901212C	SS	3/4	3/4 - 11-1/2	1.94	1-1/16	4	1.19	25 *	15.1
5901612C		1	3/4 - 11-1/2	1.94	1-1/16	4	1.19	10	21.4
5901616C			1 - 11-1/2 **	2.38	1-3/8	5	1.44	10	25.6

\* 590-SS are packaged to order

\*\* NPSH thread - extended

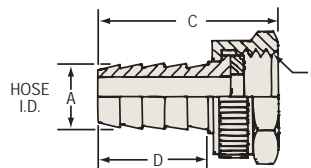

**FEMALE SWIVEL GARDEN HOSE FITTING**

Part Number	303 SS	Hose ID A	NH Thread B	Length C	Hex	No. of Barbs	Barb Length D	Std. Pkg.	Lbs. per 100 pcs.
5910612C		3/8	3/4 - 11-1/2	1.82	1-3/16	4	1.19	25	11.2
5910812C	SS	1/2	3/4 - 11-1/2	1.82	1-3/16	4	1.19	25 *	11.5
5911012C	SS	5/8	3/4 - 11-1/2	1.82	1-3/16	4	1.19	25 *	12.2
5911212C	SS	3/4	3/4 - 11-1/2	1.82	1-3/16	4	1.19	25 *	13.5
5911612C		1	3/4 - 11-1/2	2.10	1-3/16	4	1.19	10	25.2
5911616C			1 - 11-1/2 **	2.25	1-7/16	5	1.44	10	24.4

\* 591-SS are packaged to order

\*\* NPSH thread

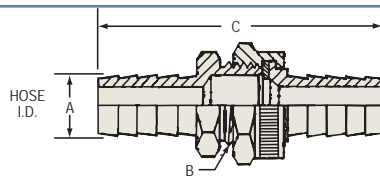

303 Stainless Steel

CDA Brass 360

**GARDEN HOSE FITTING SET - not assembled**

Part Number	303 SS	Hose ID (both fittings) A	NH Thread B	Length C	No. of Barbs	Std. Pkg.	Lbs. per 100 pcs.
5920606K		3/8	3/4 - 11-1/2	3.32	4	25	22.5
5920808K	SS	1/2	3/4 - 11-1/2	3.32	4	25 *	23.8
5921010K	SS	5/8	3/4 - 11-1/2	3.32	4	25 *	26.7
5921212K	SS	3/4	3/4 - 11-1/2	3.32	4	25 *	28.6
5921612K		1	3/4 - 11-1/2	3.60	4	10	46.7
5921616K			1 - 11-1/2 **	4.19	5	10	50.0

593 Series

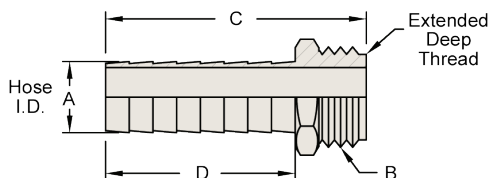

**LONG SHANK MALE GARDEN HOSE FITTING**

Part Number	Hose ID A	NH Thread B	Length C	Hex	No. of Barbs	Barb Length D	Std. Pkg.	Lbs. per 100 pcs.
5930812C	1/2	3/4 - 11-1/2	2.78	1-1/16	7	2.03	25	13.8
5931012C	5/8	3/4 - 11-1/2	2.78	1-1/16	7	2.03	25	15.1
5931212C	3/4	3/4 - 11-1/2	2.78	1-1/16	7	2.03	10	17.9
5931616C	1	1 - 11-1/2 *	2.96	1- 3/8	7	2.03	5	28.9

\* NPSH thread

594 Series

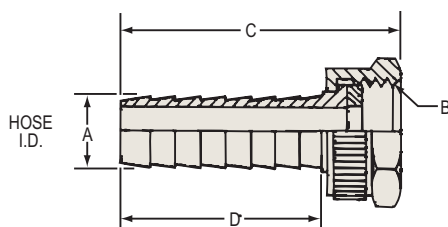

**LONG SHANK FEMALE SWIVEL GARDEN HOSE FITTING**

Part Number	Hose ID A	NH Thread B	Length C	Hex	No. of Barbs	Barb Length D	Std. Pkg.	Lbs. per 100 pcs.
5940812C	1/2	3/4 - 11-1/2	2.66	1-3/16	7	2.03	25	13.0
5941012C	5/8	3/4 - 11-1/2	2.66	1-3/16	7	2.03	25	14.2
5941212C	3/4	3/4 - 11-1/2	2.66	1-3/16	7	2.03	10	16.7
5941616C	1	1 - 11-1/2 *	2.84	1-7/16	7	2.03	5	28.8

\* NPSH thread

595 Series

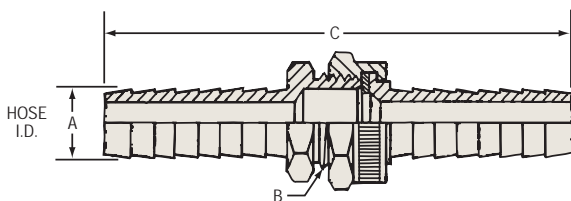

**LONG SHANK GARDEN HOSE FITTING SET \*\***

Part Number	Hose ID A (both fittings)	NH Thread B	Length C	No. of Barbs	Std. Pkg.	Lbs. per 100 pcs.
5950808K	1/2	3/4 - 11-1/2	5.05	7	25	26.9
5951010K	5/8	3/4 - 11-1/2	5.05	7	25	29.3
5951212K	3/4	3/4 - 11-1/2	5.05	7	10	34.6
5951616K	1	1 - 11-1/2 *	5.20	7	5	57.6

\* NPSH thread

\*\* Not assembled

**Features:**

- Even spray valve mist provides the proper moisture on paper roll ends
- Helps eliminate wrinkles and folder delivery problems, increasing pressroom production and reducing waste
- A slight flex of the hose in any direction (360°) activates the spray.
- Quick action with no protruding levers, thumb depressors, triggers or other devices utilized
- Positive water seal when hose is released causes the internal valve to close and immediately shut off spray.
- Sealed mechanism with no packing gland

## 833 Series



valve with hook

Female NPT Size	Description	Part #
1/4"	valve, no hook	<b>83304</b>
3/8"	valve, no hook	<b>83306</b>
1/4"	valve, with hook	<b>83304H</b>
3/8"	valve, with hook	<b>83306H</b>

## 832 Series

**Spray Valve Hose Assembly**

Part Number	Male NPT Inlet	Description
<b>8320605</b>	3/8"	3/8" ID, 5' Hose
<b>8320606</b>	3/8"	3/8" ID, 6' Hose
<b>8320608</b>	3/8"	3/8" ID, 8' Hose
<b>8320610</b>	3/8"	3/8" ID, 10' Hose
<b>8320612</b>	3/8"	3/8" ID, 12' Hose
<b>8320615</b>	3/8"	3/8" ID, 15' Hose
<b>8320605H</b>	3/8"	3/8" ID, 5' Hose with hook
<b>8320606H</b>	3/8"	3/8" ID, 6' Hose with hook
<b>8320608H</b>	3/8"	3/8" ID, 8' Hose with hook
<b>8320610H</b>	3/8"	3/8" ID, 10' Hose with hook
<b>8320612H</b>	3/8"	3/8" ID, 12' Hose with hook
<b>8320615H</b>	3/8"	3/8" ID, 15' Hose with hook

# Grease Whip Hose Assemblies and Couplings

## GWH Series



### Features:

- One piece brass crimp couplings
- 1/8-27 male NPT thread, solid base
- US manufactured to 3/16" ID hose - meets SAE100R1-AT; working pressure of **3000 PSI**
- For use with hand grease guns only
- Available with optional retail packaging or strain relief spring

### HOSE ASSEMBLIES

Part Number	Assembly Length	Strain Relief Spring	Retail Pack	Std. Pkg.
<b>GWH0800</b>	8"	Add 'S' suffix to part number		Per customer requirement
<b>GWH1200</b>	12"	Add 'S' suffix to part number	Add 'R' suffix to part number	
<b>GWH1800</b>	18"	Add 'S' suffix to part number	Add 'R' suffix to part number	
<b>GWH2400</b>	24"	Add 'S' suffix to part number		
<b>GWH3600</b>	36"	Add 'S' suffix to part number		
<b>GWH4800</b>	48"	Add 'S' suffix to part number		
<b>GWH6000</b>	60"	Add 'S' suffix to part number		

For lengths not listed, call for quote (50 minimum)



### COUPLER and FITTINGS

Part Number	Description	Material	Retail Pack	Std. Pkg.
<b>GWHC</b>	Grease hose coupler with ball check - valved shutoff	Zinc Plated Steel	Add 'R' suffix to part number	10
<b>GWHC-FF</b>	Grease hose coupler - Full Flow	Zinc Plated Steel	Add 'R' suffix to part number	10
<b>0010055C</b>	1/8-27 male NPT thread, drilled and chamfered base	Brass		100
<b>0010260C</b>	1/8-27 male NPT thread, solid base	Brass		100
<b>0010860C</b>	1/8-27 female NPT thread	Brass		100



GWHZ000  
GWHZ400

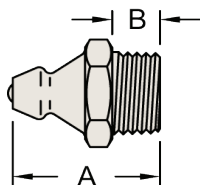

GWHZ045  
GWHZ445

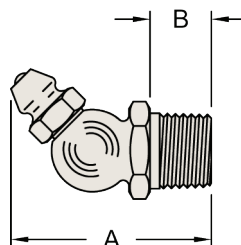

GWHZ090  
GWHZ490

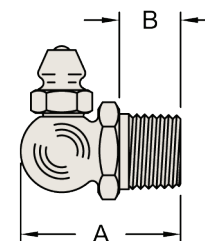

### GWHZ- ZERK FITTINGS Zinc Plated Steel

Part Number	Description	Thread	A Overall Length	B Thread Length	Hex	Std. Pkg	Lbs. per 100 pcs.
<b>GWHZ000</b>	Ball check	1/8-27 NPT	.66	.26	.43	100	1.00
<b>GWHZ045</b>	45° Angle ball check	1/8-27 NPT	.86	.28	.43	100	1.00
<b>GWHZ090</b>	90° Angle ball check	1/8-27 NPT	.83	.31	.43	100	1.00
<b>GWHZ400</b>	Ball check	1/4-28 Tapered SAE-LT	.53	.20	.312	100	1.00
<b>GWHZ445</b>	45° Angle ball check	1/4-28 Tapered SAE-LT	.80	.20	.375	100	1.00
<b>GWHZ490</b>	90° Angle ball check	1/4-28 Tapered SAE-LT	1.00	.20	.375	100	1.00

# Compression Fittings

60 Series

## SLEEVE 60C

Reference SAE 060115

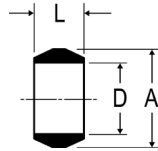

Part Number	Tube Size	A	D	L	Std. Pkg.
60C-02	1/8	.187	.130	.19	100
60C-03	3/16	.266	.192	.22	100
60C-04	1/4	.344	.255	.25	100
60C-05	5/16	.406	.318	.25	100
60C-06	3/8	.469	.382	.25	100
60C-07	7/16	.531	.444	.31	100
60C-08	1/2	.594	.507	.38	100
60C-10	5/8	.719	.632	.38	100
60C-12	3/4	.875	.758	.44	50
60C-14	7/8	1.000	.883	.41	50

## ACETAL SLEEVE 60PT

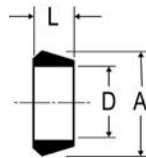

Part Number	Plastic Tube Wall	Tube Wall	A	D	L	Std. Pkg.
60PT-04	1/4	.40	.375	.254	.19	200
60PT-05	5/16	.62	.438	.317	.19	100
60PT-06	3/8	.62	.500	.379	.19	100
60PT-08	1/2	.62	.631	.507	.25	100
60PT-10	5/8	.62	.747	.632	.22	100

## NUT 61C

Reference SAE 060110

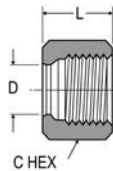

Part Number	Tube Size	Straight Thread	Hex C	D	L	Std. Pkg.
61C-02	1/8	5/16-24	3/8	.130	.38	100
61C-03	3/16	3/8-24	7/16	.192	.41	100
61C-04	1/4	7/16-24	1/2	.255	.44	100
61C-05	5/16	1/2-24	9/16	.318	.44	50
61C-06	3/8	9/16-24	5/8	.382	.47	100
61C-07	7/16	5/8-24	11/16	.444	.50	25
61C-08	1/2	11/16-20	13/16	.507	.62	50
61C-10	5/8	13/16-18	15/16	.632	.62	25
61C-12	3/4	1-18	1-3/16	.758	.69	25
61C-14	7/8	1-1/8-18	1-1/4	.890	.62	25

## LONG NUT 61CL

Reference SAE 060111

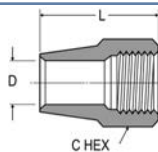

Part Number	Tube Size	Straight Thread	Hex C	D	L	Std. Pkg.
61CL-04	1/4	7/16-24	1/2	.255	.75	10
61CL-05	5/16	1/2-24	9/16	.318	.84	10
61CL-06	3/8	9/16-24	5/8	.382	.97	10
61CL-08	1/2	11/16-20	13/16	.507	1.06	10

62C Series

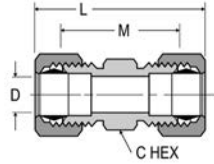

**UNION 62C**

Reference SAE 060101 BA

Part Number	Tube Size	Straight Thread	Hex C	L	M	Flow Diameter	Std. Pkg.
62C-02	1/8	5/16-24	5/16	1.05	.64	.094	25
62C-03	3/16	3/8-24	3/8	1.21	.72	.125	25
62C-04	1/4	7/16-24	7/16	1.33	.79	.188	50
62C-05	5/16	1/2-24	1/2	1.39	.85	.250	50
62C-06	3/8	9/16-24	9/16	1.52	.97	.312	50
62C-07	7/16	5/8-24	5/8	1.70	1.02	.312	10
62C-08	1/2	11/16-20	11/16	1.90	1.08	.406	25
62C-10	5/8	13/16-18	13/16	2.06	1.23	.500	10
62C-12	3/4	1-18	1	2.37	1.41	.562	10
62C-14	7/8	1-1/8-18	1-1/8	2.07	1.19	.766	10

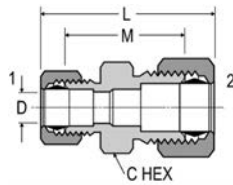

**UNION REDUCERS 62C**

Reference SAE 060101 BA

Part Number	1 Tube Size	2 Tube Size	1 Str. Thread	2 Str. Thread	Hex C	L	M	Flow Diameter	Std. Pkg.
62C-0403	3/16	1/4	3/8-24	7/16-24	7/16	1.29	.78	.125	10
62C-0604	1/4	3/8	7/16-24	9/16-24	9/16	1.46	.97	.188	10
62C-0806	3/8	1/2	9/16-24	11/16-20	11/16	1.71	1.03	.312	10
62C-1006	3/8	5/8	9/16-24	13/16-18	13/16	1.82	1.13	.312	10

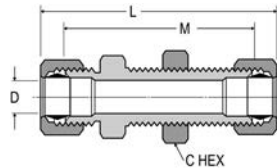

**BULKHEAD UNION 62CBH**

Part Number	Tube Size	Straight Thread	Hex C	L	M	Flow Diameter	Std. Pkg.
62CBH-04	1/4	7/16-24	9/16	2.29	1.75	.188	10
62CBH-06	3/8	9/16-24	11/16	2.42	1.88	.312	10

63 Series

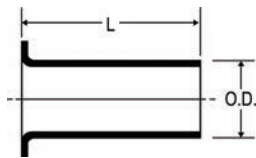

**INSERTS 63PT**

for industrial grade plastic tubing

Part Number	Tube OD	Tube Wall	L	OD	Std. Pkg.
63PT-0216	1/8	.016	.46	.080	100
63PT-0223		.023	.45	.073	200
63PT-0325	3/16	.025	.45	.135	100
63PT-0340		.040	.52	.095	100
63PT-0440	1/4	.040	.50	.163	200
63PT-0462		.062	.33	.110	50
63PT-0540	5/16	.040	.50	.232	100
63PT-0562		.062	.53	.187	100
63PT-0662	3/8	.062	.56	.250	200
63PT-0862	1/2	.062	.72	.370	100
63PT-1062	5/8	.062	.78	.488	100

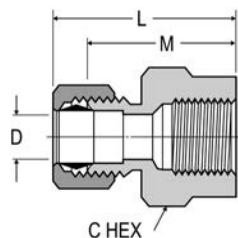

**FEMALE CONNECTOR 66C**  
Reference SAE 060103 BA

Part Number	Tube Size	NPTF Thread	UNF Thread	Hex C	L	M	Flow Diameter	Std. Pkg.
66C-0202	1/8	1/8	5/16-24	9/16	.95	.75	.094	10
66C-0302	3/16	1/8	3/8-24	9/16	1.02	.78	.125	25
66C-0304		1/4	3/8-24	11/16	1.20	.96	.125	10
66C-0402	1/4	1/8	7/16-24	9/16	1.02	.78	.188	25
66C-0404		1/4	7/16-24	11/16	1.24	1.00	.188	10
66C-0502	5/16	1/8	1/2-24	9/16	1.07	.81	.250	10
66C-0504		1/4	1/2-24	11/16	1.29	1.03	.250	10
66C-0602	3/8	1/8	9/16-24	9/16	1.06	.78	.312	10
66C-0604		1/4	9/16-24	11/16	1.34	1.06	.312	10
66C-0606		3/8	9/16-24	13/16	1.34	1.06	.312	10
66C-0608		1/2	9/16-24	1	1.54	1.27	.312	10
66C-0804	1/2	1/4	11/16-20	11/16	1.49	1.09	.406	10
66C-0806		3/8	11/16-20	13/16	1.52	1.12	.406	10
66C-0808		1/2	11/16-20	1	1.71	1.31	.406	10
66C-1008		5/8	1/2	13/16-18	1	1.80	1.38	.500

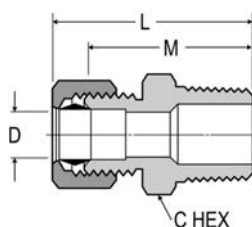

**MALE CONNECTOR 68C**  
Reference SAE 060102 BA

Part Number	Tube Size	Pipe Thread	Straight Thread	Hex C	L	M	Flow Diameter	Std. Pkg.
68C-0202	1/8	1/8	5/16-24	7/16	.97	.77	.094	25
68C-0302	3/16	1/8	3/8-24	7/16	1.08	.84	.125	50
68C-0304		1/4	3/8-24	9/16	1.27	1.03	.125	25
68C-0402	1/4	1/8	7/16-24	7/16	1.10	.86	.188	50
68C-0404		1/4	7/16-24	9/16	1.30	1.06	.188	50
68C-0406		3/8	7/16-24	11/16	1.27	1.03	.188	10
68C-0408		1/2	7/16-24	7/8	1.55	1.31	.188	10
68C-0502	5/16	1/8	1/2-24	1/2	1.15	.89	.234	25
68C-0504		1/4	1/2-24	9/16	1.33	1.07	.250	50
68C-0602	3/8	1/8	9/16-24	9/16	1.25	.97	.250	25
68C-0604		1/4	9/16-24	9/16	1.42	1.14	.312	25
68C-0606		3/8	9/16-24	11/16	1.44	1.16	.312	25
68C-0608		1/2	9/16-24	7/8	1.53	1.25	.312	25
68C-0704	7/16	1/4	5/8-24	5/8	1.50	1.17	.312	10
68C-0804	1/2	1/4	11/16-20	11/16	1.62	1.22	.312	10
68C-0806		3/8	11/16-20	11/16	1.60	1.20	.406	25
68C-0808		1/2	11/16-20	7/8	1.71	1.31	.406	25
68C-1006	5/8	3/8	13/16-18	13/16	1.73	1.31	.406	10
68C-1008		1/2	13/16-18	7/8	1.90	1.48	.500	10
68C-1012		3/4	13/16-18	1-1/16	1.98	1.56	.500	10
68C-1208	3/4	1/2	1-18	1	2.05	1.60	.562	10
68C-1212		3/4	1-18	1-1/16	2.08	1.63	.656	10
68C-1412		7/8	3/4	1-1/8-18	1-1/8	1.76	1.41	.750

164C and 264C Series

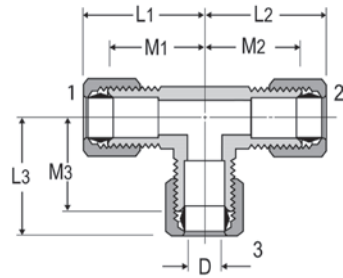

164C

**UNION TEE 164C-264C**

Reference SAE 060401 BA

Part Number	Tube Size 1 and 2	Tube Size 3	Straight Thread	L1	L2	L3	M1	M2	M3	Flow Diameter	Std. Pkg.
164C-02	1/8	1/8	5/16-24	.82	.82	.82	.61	.61	.61	.094	10
264C-03	3/16	3/16	3/8-24	.84	.84	.84	.60	.60	.60	.125	10
164C-04	1/4	1/4	7/16-24	.86	.86	.86	.61	.61	.61	.188	25
164C-05	5/16	5/16	1/2-24	.98	.98	.98	.71	.71	.71	.250	10
164C-06	3/8	3/8	9/16-24	1.03	1.03	1.03	.74	.74	.74	.312	25
164C-08	1/2	1/2	11/16-20	1.34	1.34	1.34	.93	.93	.93	.406	10
164C-10	5/8	5/8	13/16-18	1.54	1.54	1.54	1.08	1.08	1.08	.500	10
164C-06-06-04	3/8	1/4	---	1.03	1.03	.96	.75	.75	.72	.188	25
164C-08-08-06	1/2	3/8	---	1.34	1.34	1.16	.94	.94	.88	.312	10

165C Series

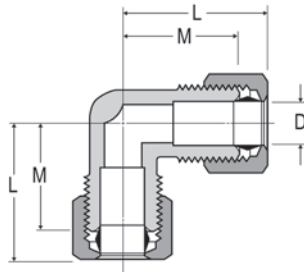

**UNION ELBOW 165C**

Reference SAE 060201 BA

Part Number	Tube Size	Straight Thread	L	M	Flow Diameter	Std. Pkg.
165C-02	1/8	5/16-24	.82	.61	.094	10
165C-03	3/16	3/8-24	.87	.61	.125	10
165C-04	1/4	7/16-24	.88	.61	.188	10
165C-05	5/16	1/2-24	.95	.71	.250	10
165C-06	3/8	9/16-24	1.03	.74	.312	10
165C-07	7/16	5/8-24	1.16	.82	.312	5
165C-08	1/2	11/16-20	1.34	.93	.406	10
165C-10	5/8	13/16-18	1.48	1.05	.500	10
165C-12	3/4	1-18	1.65	1.17	.560	5



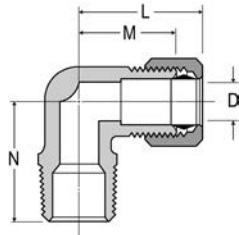

**MALE ELBOW 169C-269C**  
Reference SAE 060202 BA

Part Number	Tube Size	Pipe Thread	Straight Thread	L	M	N	Flow Diameter D	Std. Pkg.
169C-0202	1/8	1/8	5/16-24	.80	.60	.67	.094	10
169C-0302	3/16	1/8	3/8-24	.84	.61	.69	.125	10
169C-0304		1/4	3/8-24	.86	.64	.93	.125	10
169C-0402	1/4	1/8	7/16-24	.86	.61	.74	.188	50
169C-0404		1/4	7/16-24	.86	.62	.94	.188	50
169C-0406		3/8	7/16-24	.93	.68	1.00	.188	10
169C-0502	5/16	1/8	1/2-24	.88	.61	.74	.234	10
169C-0504		1/4	1/2-24	.95	.71	.93	.250	25
169C-0506		3/8	1/2-24	1.01	.75	1.00	.250	10
169C-0602	3/8	1/8	9/16-24	1.03	.74	.74	.234	10
169C-0604		1/4	9/16-24	1.03	.74	.93	.312	25
169C-0606		3/8	9/16-24	1.03	.75	1.00	.312	25
169C-0608		1/2	9/16-24	1.22	.94	1.27	.312	10
169C-0804	1/2	1/4	11/16-20	1.34	.94	1.00	.312	10
169C-0806		3/8	11/16-20	1.34	.93	1.11	.406	10
169C-0808		1/2	11/16-20	1.48	1.06	1.15	.406	10
169C-1008		5/8	1/2	13/16-18	1.48	1.06	1.31	.500
169C-1208	3/4	1/2	1-18	1.64	1.18	1.49	.562	5
169C-1212		3/4	1-18	1.70	1.27	1.58	.562	5

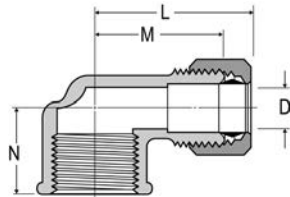

**FEMALE ELBOW 170C**  
Reference SAE 060203 BA

Part Number	Tube Size	Pipe Thread	Straight Thread	L	M	N	Flow Diameter D	Std. Pkg.
170C-0202	1/8	1/8	5/16-24	.89	.69	.56	.094	10
170C-0302	3/16	1/8	3/8-24	.98	.73	.56	.125	25
170C-0402	1/4	1/8	7/16-24	.93	.69	.56	.188	25
170C-0404		1/4	7/16-24	1.02	.78	.70	.188	25
170C-0604	3/8	1/4	9/16-24	1.06	.79	.73	.312	10
170C-0606		3/8	9/16-24	1.22	.94	.69	.312	10
170C-0704	7/16	1/4	5/8-24	1.27	.93	.73	.312	5
170C-0806	1/2	3/8	11/16-20	1.34	1.00	.69	.406	10

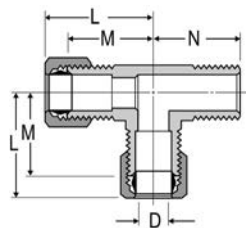

**MALE RUN TEE 171C**

Part Number	Tube Size	Pipe Thread	Straight Thread	L	M	N	Flow Diameter D	Std. Pkg.
171C-0202	1/8	1/8	5/16-24	.82	.61	.71	.094	10
171C-0302	3/16	1/8	3/8-24	.86	.61	.71	.125	10
171C-0402	1/4	1/8	7/16-24	.90	.64	.75	.188	10
171C-0404	1/4	1/4	7/16-24	.90	.64	.75	.188	10

172C Series

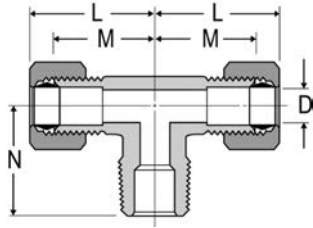

**MALE BRANCH TEE 172C**  
Reference SAE 060425 BA

Part Number	Tube Size	Pipe Thread	Straight Thread	L	M	N	Flow Diameter D	Std. Pkg.
172C-0202	1/8	1/8	5/16-24	.82	.61	.71	.094	10
172C-0302	3/16	1/8	3/8-24	.86	.61	.71	.125	10
172C-0402	1/4	1/8	7/16-24	.86	.61	.74	.188	10
172C-0404		1/4	7/16-24	.93	.69	.92	.188	10
172C-0602	3/8	1/8	9/16-24	1.03	.75	.75	.234	10
172C-0604		1/4	9/16-24	1.09	.77	1.03	.312	10
172C-0606		3/8	9/16-24	1.09	.81	1.00	.312	10
172C-0806	1/2	3/8	11/16-20	1.34	.93	1.10	.406	10

176C Series

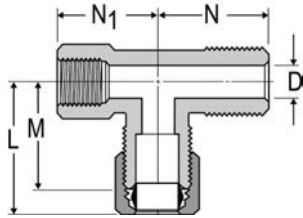

**ADAPTER TEE 176C**

Part Number	Tube Size	Pipe Thread	Straight Thread	L	M	N	N1	Flow Diameter D	Std. Pkg.
176C-0402	1/4	1/8	7/16-24	.93	.69	.75	.66	.189	10

177C Series

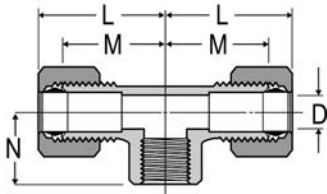

**FEMALE BRANCH TEE 177C**

Part Number	Tube Size	Pipe Thread	Straight Thread	L	M	N	Flow Diameter D	Std. Pkg.
177C-0402	1/4	1/8	7/16-24	.86	.63	.53	.188	10

179C Series

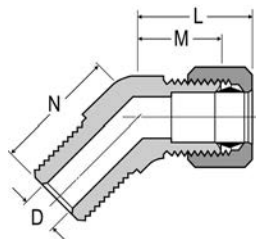

**45° ELBOW 179C**

Part Number	Tube Size	Pipe Thread	Straight Thread	L	M	N	Flow Diameter D	Std. Pkg.
179C-0402	1/4	1/8	7/16-24	.90	.66	.56	.188	10
179C-0404		1/4	7/16-24	.80	.56	.84	.188	10
179C-0602	3/8	1/8	9/16-24	.90	.63	.65	.234	10
179C-0604		1/4	9/16-24	.90	.63	.84	.312	10
179C-0606		3/8	9/16-24	.97	.75	.95	.312	10

639C Series

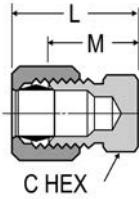

**SEAL PLUG 639C**

Part Number	Tube Size	Straight Thread	Hex C	L	M	Std. Pkg.
639C-04	1/4	7/16-24	7/16	.74	.50	25

682C Series

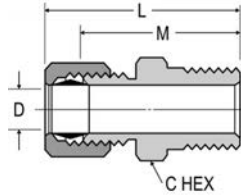

**STRAIGHT THROUGH TANK FITTING 682C**

Part Number	Tube Size	Pipe Thread	Straight Thread	Hex C	L	M	Flow Diameter D	Std. Pkg.
682C-0302	3/16	1/8	3/8-24	7/16	1.06	.84	.195	10
682C-0606	3/8	3/8	9/16-24	11/16	1.44	1.16	.387	10
682C-0808	1/2	1/2	11/16-20	7/8	1.90	1.31	.516	10

**Specifications:**

Listed with Underwriter's Laboratories for flammable liquid. Compression fittings meet functional requirements of SAE J-512, ASA and ASME.

**Applications:**

Use with copper, aluminum and thermoplastic tubing. Not recommended for steel tubing. Manufactured for low and medium pressure tubing connection work where excessive vibration or tube movement is not involved. Not recommended for applications using gaseous media.

**Working Pressure Ranges:**

Temperature and type of tubing used are important factors and the table to the right is a good guide for proper selection. Temperature **73°F**. For thermoplastic tubing see manufacturers recommendation for pressure range.

**Temperature Ranges:**

From **-65° to +250°F** with soft metal tubing. For thermoplastic tubing see manufacturers recommendation for tubing temperature range.

**Assembly Instructions:**

1. Slide nut, then sleeve onto tubing. The thread end of the nut must face out.
2. Insert the tube into the fitting. Be sure the tube is bottomed on the fitting shoulder.
3. Assemble nut to body, and tighten 'hand tight'. Then follow the number of wrench turns as indicated in the table to the right.

PSI	Tube OD (inches)	Tube Wall (inches)
400	1/8	.030
400	3/16	.030
300	1/4	.030
300	5/16	.032
200	3/8	.032
200	1/2	.032
150	5/8	.035
100	3/4	.035
75	7/8	.035

Fitting Size	Tube Size	Turns required to seal from hand tight	
		60C with soft metal tubing	60C with thermoplastic tubing
2	1/8	1-1/4	--
3	3/16	1-1/4	--
4	1/4	1-1/4	2
5	5/16	1-1/4	2
6	3/8	2-1/4	2
8	1/2	2-1/4	2
10	5/8	2-1/4	2
12	3/4	2-1/4	2
14	7/8	2-1/4	--

**Features:**

- Maximum working pressure: **150 PSI**
- Temperature range: **-40°F to + 200°F**



**TUBING NAB**

Reference SAE J844, TYPE A and B, D.O.T. FMVSS 106

Part Number	Tube Size	Standard Color	Std. Pkg.
<b>NAB3</b>	3/16	black	100'
<b>NAB4</b>	1/4	black	100'
<b>NAB4B</b>	1/4	blue	100'
<b>NAB4R</b>	1/4	red	100'
<b>NAB6</b>	3/8	black	100'
<b>NAB6B</b>	3/8	blue	100'
<b>NAB6R</b>	3/8	red	100'
<b>NAB8</b>	1/2	black	100'
<b>NAB10</b>	5/8	black	100'
<b>NAB12</b>	3/4	black	100'

**TUBING CUTTER**

Part Number	Description
<b>TC97</b>	Maximum OD 9/16"
<b>TC97RB</b>	Replacement blade



**AIR BRAKE FITTINGS**

**Application:**

- Designed for use in air brake systems or cab controls

**Features:**

- Utilize ribbed sleeve for compression and positive grip
- Machined from CA360, CA345, or CA377 brass
- Pre-applied thread sealant on all male pipe threads
- Maximum operating pressure: **150 PSI**
- Temperature range: **-40°F to 200°F**
- Compatible tubing: SAE J844 type A and B
- Specifications: meets D.O.T FMVSS 571.106 and SAE J1131, and SAE J2494

**Assembly Instructions:**

1. Cut tubing squarely - maximum of 15° angle allowance.
2. Check that port or mating part is clean and free of debris.
3. Insert tubing into fitting until it bottoms on seat.
4. Tighten nut with wrench until one thread remains visible on the fitting body (this will allow for a number of remakes) or, the nut should be screwed down finger tight, then wrench-tightened as indicated in the table to the right.

Tube Size	Turns required to seal from hand tight
3/16	2-1/2
1/4	3
3/8 and 1/2	4
5/8 and 3/4	3-1/2

**SLEEVE 60NAB**

Reference SAE 100115

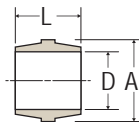

Part Number	Tube Size	A	D	L	Std. Pkg.
<b>60NAB3</b>	3/16	.255	.194	.23	100
<b>60NAB4</b>	1/4	.356	.256	.30	100
<b>60NAB6</b>	3/8	.479	.384	.39	100
<b>60NAB8</b>	1/2	.624	.509	.43	100
<b>60NAB10</b>	5/8	.746	.634	.49	100
<b>60NAB12</b>	3/4	.922	.760	.54	50

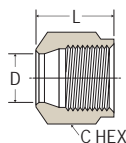

**NUT 61NAB**

Reference SAE 100110

Part Number	Tube Size	Straight Thread	Hex C	D	L	Std. Pkg.
61NAB3	3/16	5/16-24	7/16	.194	.40	100
61NAB4	1/4	7/16-24	9/16	.256	.45	100
61NAB6	3/8	17/32-24	5/8	.384	.63	100
61NAB8	1/2	11/16-20	13/16	.509	.72	50
61NAB10	5/8	13/16-18	15/16	.634	.77	25
61NAB12	3/4	1-18	1-1/8	.762	.81	25

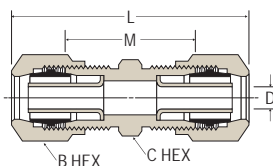

**UNION 62NAB**

Reference SAE 100101 BA

Part Number	Tube Size	Straight Thread	Hex B	Hex C	L	M	Flow D	Std. Pkg.
62NAB4	1/4	7/16-24	9/16	7/16	1.49	.83	.137	10
62NAB6	3/8	17/32-24	5/8	9/16	2.00	1.08	.217	10
62NAB8	1/2	11/16-20	13/16	11/16	2.33	1.29	.338	10
62NAB10	5/8	13/16-18	15/16	13/16	2.39	1.41	.398	10
62NAB12	3/4	1-18	1-1/8	1	2.60	1.58	.523	10

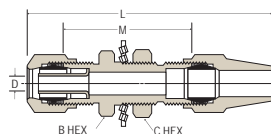

**BULKHEAD UNION 62NABH**  
(NAB and air brake)

Part Number	Tube Size	Straight Thread	Hex B	Hex C	L	M	Flow D	Std. Pkg.
62NABH4	1/4	7/16-24	9/16	9/16	2.28	1.38	.137	10
62NABH6	3/8	17/32-24	11/16	3/4	2.97	1.62	.217	10
62NABH8	1/2	11/16-20	13/16	1	3.36	1.88	.338	10

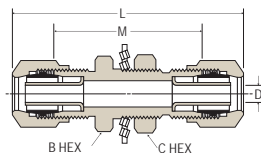

**BULKHEAD UNION 62NBH**

Part Number	Tube Size	Straight Thread	Hex B	Hex C	L	M	Flow D	Std. Pkg.
62NBH3	3/16	5/16-24	7/16	7/16	1.80	1.21	.087	10
62NBH4	1/4	7/16-24	9/16	9/16	2.04	1.38	.137	10
62NBH6	3/8	17/32-24	11/16	3/4	2.54	1.62	.21	10
62NBH8	1/2	11/16-20	13/16	1	2.92	1.88	.33	10

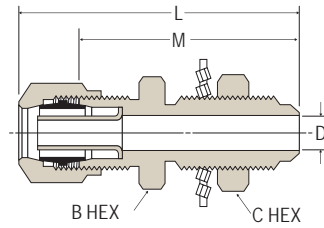

**BULKHEAD UNION 62NFBH**

Part Number	Tube Size	Straight Thread	Hex B	Hex C	L	M	D	Std. Pkg.
62NFBH4	1/4	7/16-24	9/16	9/16	2.04	1.38	.137	10
62NFBH6	3/8	17/32-24	11/16	3/4	2.54	1.62	.217	10
62NFBH8	1/2	11/16-20	13/16	1	2.92	1.88	.338	10
62NFBH10	5/8	13/16-18	15/16	1	3.04	2.02	.398	10

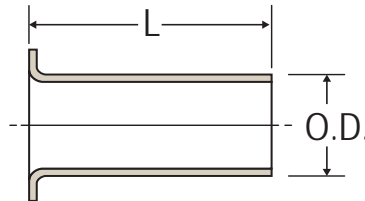

**STAINLESS INSERT 63NAB**  
(for SAE J844 tubing)

Part Number	Tube Size	L	OD	Std. Pkg.
63NAB4	1/4	.53	.163	200
63NAB6	3/8	.64	.245	200
63NAB8	1/2	.81	.370	100
63NAB10	5/8	.86	.434	100
63NAB12	3/4	1.04	.559	100

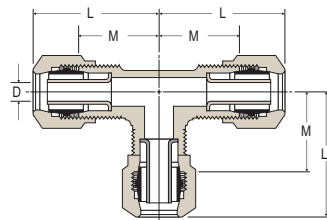

**UNION TEE 64NAB**  
Reference SAE 100401 BA

Part Number	Tube Size	Straight Thread	L	M	Flow D	Std. Pkg.
64NAB4	1/4	7/16-24	.95	.62	.13	25
64NAB6	3/8	17/32-24	1.24	.78	.21	25
64NAB8	1/2	11/16-20	1.45	.93	.33	10
64NAB10	5/8	13/16-18	1.58	1.09	.39	10



**Call Toll Free: 1-866-711-4673**  
**International: +1-727-342-5086**



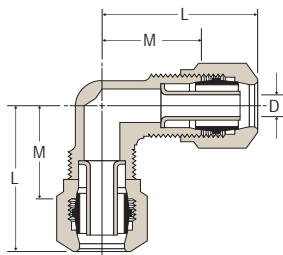

**UNION ELBOW 65NAB**  
Reference SAE 100201 BA

Part Number	Tube Size	Straight Thread	L	M	Flow D	Std. Pkg.
65NAB4	1/4	7/16-24	.95	.62	.13	10
65NAB6	3/8	17/32-24	1.25	.79	.21	10
65NAB8	1/2	11/16-20	1.45	.93	.33	10
65NAB10	5/8	13/16-18	1.58	1.09	.39	10

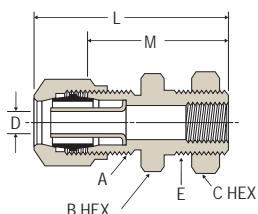

**BULKHEAD UNION 66NBH**

Part Number	Tube Size	Pipe Size	Straight Thread A	Straight Thread E	Hex B	Hex C	L	M	Flow D	Std. Pkg.
66NBH86	1/2	3/8	11/16-20	7/8-14	1-1/16	1-1/16	1.94	1.42	.338	10

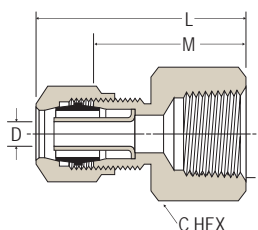

**FEMALE CONNECTOR 66NAB**  
Reference SAE 100103 BA

Part Number	Tube Size	Pipe Thread	Straight Thread	Hex C	L	M	Flow D	Std. Pkg.
66NAB42	1/4	1/8	7/16-24	9/16	1.17	.84	.13	25
66NAB44		1/4	7/16-24	11/16	1.40	1.07	.13	10
66NAB62	3/8	1/8	17/32-24	9/16	1.46	1.00	.21	10
66NAB64		1/4	17/32-24	11/16	1.64	1.18	.21	10
66NAB86 *	1/2	3/8	11/16-20	7/8	1.79	1.27	.33	10
66NAB88		1/2	11/16-20	1-1/16	1.91	1.38	.33	10
66NAB106	5/8	3/8	13/16-18	7/8	1.87	1.38	.39	10
66NAB108		1/2	13/16-18	1-1/16	1.99	1.60	.39	10

\* Not full hex as shown

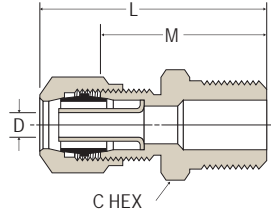

**MALE CONNECTOR 68NAB**

Reference SAE 100102 BA

Thread sealant may be white or burnt orange

Part Number	Tube Size	Pipe Thread	Straight Thread	Hex C	L	M	Flow D	Std. Pkg.
68NAB31VS	3/16	1/16	5/16-24	3/8	1.16	.87	.087	25
68NAB32VS		1/8	5/16-24	7/16	1.15	.86	.087	50
68NAB34VS		1/4	5/16-24	9/16	1.35	1.05	.087	25
68NAB42VS	1/4	1/8	7/16-24	7/16	1.22	.89	.13	50
68NAB44VS		1/4	7/16-24	9/16	1.43	1.09	.13	50
68NAB46VS		3/8	7/16-24	11/16	1.47	1.14	.13	10
68NAB62VS	3/8	1/8	17/32-24	9/16	1.49	1.03	.21	25
68NAB64VS		1/4	17/32-24	9/16	1.67	1.21	.21	25
68NAB66VS		3/8	17/32-24	11/16	1.70	1.21	.21	25
68NAB68VS		1/2	17/32-24	7/8	1.89	1.43	.21	25
68NAB84VS	1/2	1/4	11/16-20	11/16	1.85	1.32	.33	10
68NAB86VS		3/8	11/16-20	11/16	1.85	1.32	.33	25
68NAB88VS		1/2	11/16-20	7/8	2.04	1.52	.33	25
68NAB106VS	5/8	3/8	13/16-18	13/16	1.86	1.37	.398	10
68NAB108VS		1/2	13/16-18	7/8	2.07	1.56	.398	10
68NAB126VS	3/4	3/8	1-18	1	2.00	1.49	.440	10
68NAB128VS		1/2	1-18	1	2.19	1.68	.523	10
68NAB1212VS		3/4	1-18	1-1/16	2.22	1.71	.523	10

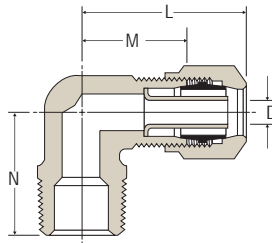

**MALE ELBOW 69NAB**

Reference SAE 100202 BA

Thread sealant may be white or burnt orange

Part Number	Tube Size	Pipe Thread	Straight Thread	L	M	N	Flow D	Std. Pkg.
69NAB32VS	3/16	1/8	5/16-24	.90	.60	.67	.087	10
69NAB34VS		1/4	5/16-24	.91	.62	.87	.087	10
69NAB42VS	1/4	1/8	7/16-24	.95	.62	.66	.13	50
69NAB44VS		1/4	7/16-24	1.00	.68	.87	.13	50
69NAB46VS		3/8	7/16-24	1.16	.73	.86	.13	10
69NAB62VS	3/8	1/8	17/32-24	1.19	.73	.75	.21	10
69NAB64VS		1/4	17/32-24	1.25	.79	.92	.21	25
69NAB66VS		3/8	17/32-24	1.30	.84	.91	.21	25
69NAB68VS		1/2	17/32-24	1.40	.94	1.10	.21	10
69NAB84VS	1/2	1/4	11/16-20	1.38	.86	.99	.33	10
69NAB86VS		3/8	11/16-20	1.44	.92	.99	.33	10
69NAB88VS		1/2	11/16-20	1.55	1.03	1.18	.33	10
69NAB106VS	5/8	3/8	13/16-18	1.49	1.00	1.05	.39	10
69NAB108VS		1/2	13/16-18	1.58	1.09	1.24	.39	5
69NAB128VS	3/4	1/2	1-18	1.70	1.19	1.33	.52	5
69NAB1212VS		3/4	1-18	1-1/16	1.77	1.26	.52	5



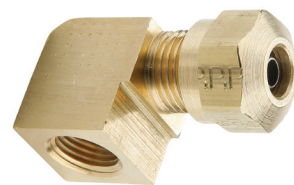
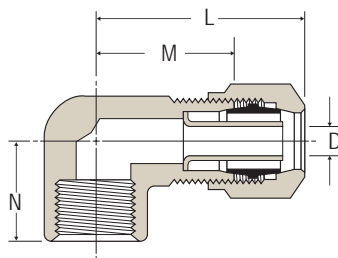

### FEMALE ELBOW 70NAB

Reference SAE 100203 BA

Part Number	Tube Size	Pipe Thread	Straight Thread	L	M	N	Flow D	Std. Pkg.
70NAB32	3/16	1/8	5/16-24	.96	.67	.52	.087	10
70NAB42	1/4	1/8	7/16-24	1.02	.69	.52	.13	10
70NAB44		1/4	7/16-24	1.11	.78	.71	.13	50
70NAB62	3/8	1/8	17/32-24	1.29	.83	.59	.21	50
70NAB64 *		1/4	17/32-24	1.25	.80	.58	.21	10
70NAB66		3/8	17/32-24	1.39	.93	.77	.21	10
70NAB86	1/2	3/8	11/16-20	1.55	1.03	.82	.33	25
70NAB88		1/2	11/16-20	1.65	1.13	1.01	.33	25
70NAB108	5/8	1/2	13/16-18	1.70	1.19	1.07	.39	10

\* Rounded elbow - part not as pictured

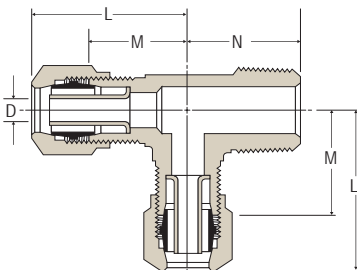

### MALE RUN TEE 71NAB

Reference SAE 100424 BA

Thread sealant may be white or burnt orange

Part Number	Tube Size	Pipe Thread	Straight Thread	L	M	N	Flow D	Std. Pkg.
71NAB42VS	1/4	1/8	7/16-24	.95	.62	.66	.13	10
71NAB44VS		1/4	7/16-24	1.00	.68	.87	.13	10
71NAB64VS	3/8	1/4	17/32-24	1.25	.79	.92	.21	10
71NAB66VS		3/8	17/32-24	1.30	.84	.91	.21	10
71NAB86VS	1/2	3/8	11/16-20	1.45	.93	.99	.33	10
71NAB88VS		1/2	11/16-20	1.55	1.03	1.18	.33	10
71NAB108VS	5/8	1/2	13/16-18	1.60	1.09	1.24	.39	10

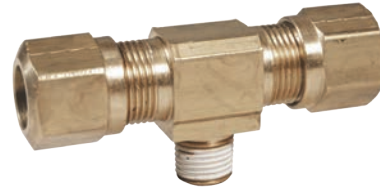
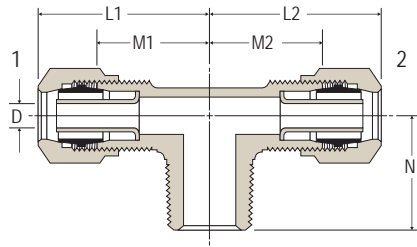

**MALE BRANCH TEE 72NAB**

Reference SAE 100425 BA

Thread sealant may be white or burnt orange

Part Number	Tube 1	Tube 2	Pipe Thread	Straight Thread	L <sup>1</sup>	L <sup>2</sup>	M <sup>1</sup>	M <sup>2</sup>	N	Flow D	Std. Pkg.
72NAB32VS	3/16	3/16	1/8	7/16-24	.90	.90	.61	.61	.66	.087	10
72NAB42VS	1/4	1/4	1/8	7/16-24	.95	.95	.62	.62	.66	.13	10
72NAB44VS		1/4	1/4	7/16-24	1.00	1.00	.68	.68	.87	.13	10
72NAB62VS	3/8	3/8	1/8	17/32-24	1.18	1.18	.72	.72	.75	.217	10
72NAB64VS		3/8	1/4	17/32-24	1.25	1.25	.81	.81	.92	.21	10
72NAB66VS		3/8	3/8	17/32-24	1.30	1.30	.84	.84	.91	.21	10
72NAB84VS	1/2	1/2	1/4	11/16-20	1.41	1.41	.89	.89	.99	.33	10
72NAB86VS		1/2	3/8	11/16-20	1.45	1.45	.93	.93	.99	.33	10
72NAB88VS		1/2	1/2	11/16-20	1.55	1.55	1.03	1.03	1.17	.33	10
72NAB108VS	5/8	5/8	1/2	13/16-18	1.60	1.60	1.09	1.09	1.24	.39	10

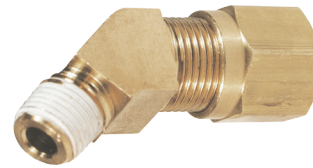
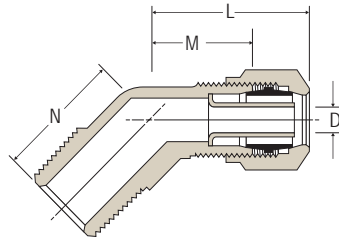

**45° ELBOW 79NAB**

Reference SAE 100302 BA

Thread sealant may be white or burnt orange

Part Number	Tube Size	Pipe Thread	Straight Thread	L	M	N	Flow D	Std. Pkg.
79NAB42VS	1/4	1/8	7/16-24	.81	.49	.63	.13	10
79NAB44VS		1/4	7/16-24	.93	.60	.85	.13	10
79NAB62VS	3/8	1/8	17/32-24	1.17	.71	.68	.21	10
79NAB64VS		1/4	17/32-24	1.17	.71	.85	.21	10
79NAB66VS		3/8	17/32-24	1.21	.75	.94	.21	10
79NAB68VS	1/2	1/2	17/32-24	1.24	.78	1.16	.21	10
79NAB84VS		1/4	11/16-20	1.36	.84	.94	.33	10
79NAB86VS		1/2	3/8	11/16-20	1.36	.84	.94	.33
79NAB88VS	5/8	1/2	11/16-20	1.39	.87	1.16	.33	10
79NAB106VS		3/8	13/16-18	1.43	.94	.98	.39	5
79NAB108VS		1/2	13/16-18	1.42	.93	1.16	.39	5
79NAB120VS	3/4	1/2	1 1/8-18	1.64	1.10	1.18	.51	5

**AIR BRAKE FITTINGS - RUBBER HOSE**

**Application:**

- For use with SAEJ1402 air brake hose in making hose assemblies

**Compliances:**

- Will meet D.O.T. FMVSS 571-106 standards when used with SAE J1402 Air Brake Hose

**Material:**

- Brass: Alloy 360

**Performance:**

- Working Pressure: up to **225 PSI**
- Temperature: **-50°F to +212°F**

**Assembly Instructions:**

1. Slide nut onto hose
2. Slide sleeve onto hose with tapered edge toward fitting body
3. Firmly bottom the hose into fittings
4. Screw nut onto body until it contacts the fitting's body hex

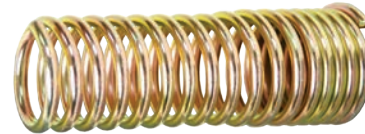
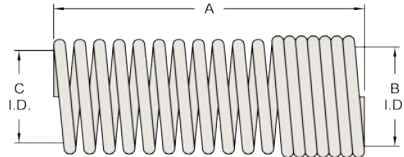

**56RBSG**  
*Spring*

Part Number	Hose Size	A	B	C	Std. Pkg.
<b>56RBSG-06</b>	3/8	2.70	.87	.87	5
<b>56RBSG-08</b>	1/2	2.70	.96	.96	5

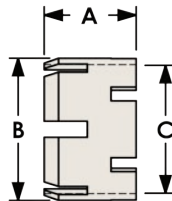

**60RB**  
*Sleeve*

Part Number	Hose Size	A Length	B O.D.	C I.D.	Std. Pkg.
<b>60RB-06</b>	3/8	.64	.91	.80	10
<b>60RB-08</b>	1/2	.64	1.02	.92	5

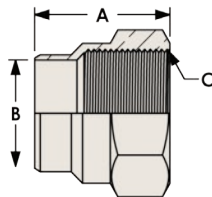

**61RB**  
*Nut*

Part Number	Hose Size	C Thread	Hex	A Length	B I.D.	Std. Pkg.
<b>61RB-06</b>	3/8	31/32-20	1-1/32	1.13	.78	10
<b>61RB-08</b>	1/2	1-3/32-20	1-1/4	1.20	.92	10

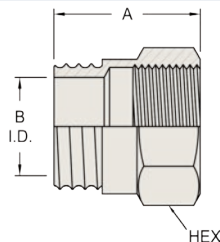

**61RBSG**  
*Spring Guard Nut*

Part Number	Hose Size	Straight Thread	Hex	A	B	Std. Pkg.
<b>61RBSG-06</b>	3/8	31/32-20	1-1/32	1.20	.78	5
<b>61RBSG-08</b>	1/2	1-3/32-20	1-1/4	1.20	.92	5

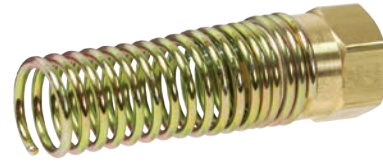
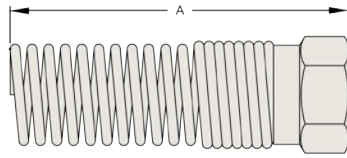

**67RBSG**

*Air Brake Hose Nut & Attached Spring*

Part Number	Length	Std. Pkg.
<b>67RBSG-06</b>	3.55	5
<b>67RBSG-08</b>	3.50	5

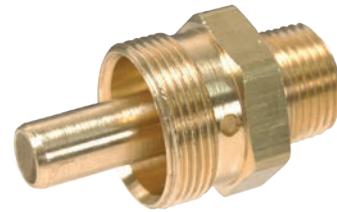
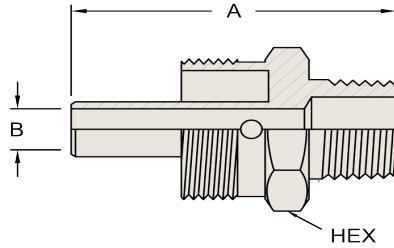

**68RB**

*Male Connector Body Only*

Part Number	Hose Size	Straight Thread	Pipe Thread	Hex	A	B	Std. Pkg.
<b>68RB-0604B</b>	3/8	31/32-20	1/4	31/32	1.93	.299	10
<b>68RB-0606B</b>		31/32-20	3/8	31/32	1.93	.299	10
<b>68RB-0608B</b>		31/32-20	1/2	31/32	2.12	.299	10
<b>68RB-0806B</b>	1/2	1-3/32-20	3/8	1-1/8	1.96	.397	5
<b>68RB-0808B</b>		1-3/32-20	1/2	1-1/8	2.15	.397	5

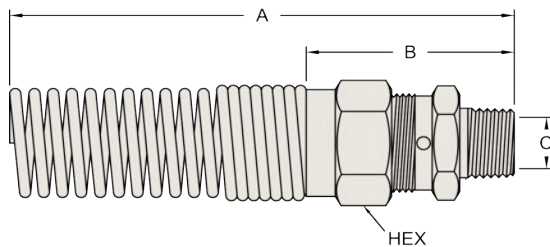

**68RBSG**

*Male Connector With Spring Guard*

Part Number	Hose Size	Pipe Thread	Hex	A	B	C	Std. Pkg.
<b>68RBSG-0604</b>	3/8	1/4	1-1/16	4.69	1.96	.299	2
<b>68RBSG-0606</b>		3/8	1-1/16	4.8	2.05	.299	2
<b>68RBSG-0608</b>		1/2	1-1/16	4.9	2.15	.299	2
<b>68RBSG-0806</b>	1/2	3/8	1-1/4	5.0	2.00	.397	2
<b>68RBSG-0808</b>		1/2	1-1/4	5.25	2.25	.397	2

**Application:**

- For use where "Lead Free" fittings are required

**Conforms To:**

- Safe Water Drinking Act (SWDA) of Jan. 4, 2014
- California AB1953
- RoHS Compliant

**Materials:**

- Lead free brass <=0.25% lead
- Alloy CA2745
- Alloy C46400

**102 Series**

Male Hose Barb - NPT



Part Number	Hose ID x Male NPT Thread
1020302CLF	3/16 x 1/8
1020402CLF	1/4 x 1/8
1020404CLF	1/4 x 1/4
1020502CLF	5/16 x 1/8
1020504CLF	5/16 x 1/4
1020602CLF	3/8 x 1/8
1020604CLF	3/8 x 1/4
1020606CLF	3/8 x 3/8
1020608CLF	3/8 x 1/2
1020804CLF	1/2 x 1/4
1020806CLF	1/2 x 3/8
1020808CLF	1/2 x 1/2
1021008CLF	5/8 x 1/2
1021208CLF	3/4 x 1/2
1021212CLF	3/4 x 3/4

**163 Series**

Solid Hex Head Plug - NPT



Part Number	NPT Thread
1630200CLF	1/8
1630400CLF	1/4

**165 Series**

Close Pipe Nipple - NPT

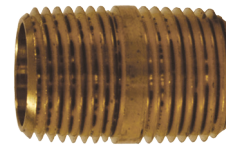

Part Number	NPT Thread x NPT Thread
1650202CLF	1/8 x 1/8
1650404CLF	1/4 x 1/4
1650606CLF	3/8 x 3/8
1650808CLF	1/2 x 1/2
1651212CLF	3/4 x 3/4

**104 Series**

Female Hose Barb - Solid - NPT



Part Number	Hose ID X Female NPT Thread
1040404CLF	1/4 x 1/4
1040604CLF	3/8 x 1/4
1040606CLF	3/8 x 3/8
1040608CLF	3/8 x 1/2
1040808CLF	1/2 x 1/2

**166 Series**

Long Pipe Nipple - NPT



Part Number	NPT Thread x OAL
1660230CLF	1/8 x 3"
1660240CLF	1/8 x 4"
1660415CLF	1/4 x 1 1/2"
1660420CLF	1/4 x 2"
1660430CLF	1/4 x 3"
1660440CLF	1/4 x 4"
1660615CLF	3/8 x 1 1/2"
1660620CLF	3/8 x 2"
1660625CLF	3/8 x 2 1/2"
1660630CLF	3/8 x 3"
1660640CLF	3/8 x 4"
1660815CLF	1/2 x 1 1/2"

**129 Series**

90° Elbow - NPT



Part Number	Hose ID x Male NPT
1290404CLF	1/4 x 1/4
1290604CLF	3/8 x 1/4
1290606CLF	3/8 x 3/8

**143 Series**

Female Swivel Hose Barb - Dual Angle Seat



Part Number	Hose ID x Tube OD x UNF Thread
-------------	--------------------------------

**178 Series**

Hose Splicer



Part Number	Hose ID x Hose ID
1780404CLF	1/4 x 1/4
1780606CLF	3/8 x 3/8



**179 Series**  
Hose Barb Tee Splicer

Part Number	Hose ID
1790404CLF	¼ x ¼ x ¼
1790606CLF	⅜ x ⅜ x ⅜



**211 Series**  
Square Head Plug - PTF

Part Number	PTF Thread
2110200C	⅛
2110400C	¼
2110600C	⅜
2110800C	½
2111200C	¾



**213 Series**  
Pipe Cap - NPT

Part Number	NPT Thread
2130200CLF	⅛
2130400CLF	¼
2130600CLF	⅜
2130800CLF	½
2131200CLF	¾



**219 Series**  
Hex Socket Plug - NPT

Part Number	NPT Thread
2190200C	⅛
2190400C	¼
2190600C	⅜
2190800C	½
2191200C	¾

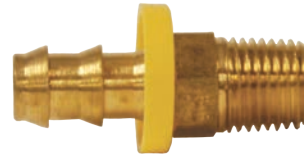

**272 Series**  
"Lok-On" Male NPT Hose Barb

Part Number	Hose ID x Male NPT Thread
2720402CLF	¼ x ⅛
2720404CLF	¼ x ¼
2720604CLF	⅜ x ¼
2720606CLF	⅜ x ⅜
2720806CLF	½ x ⅜
2720808CLF	½ x ½



**287 Series**  
"Lok-On" Female Swivel Hose Barb - Dual Angle

Part Number	Hose ID x Tube OD x UNF Thread
2870407CLF	1/4x 1/4 x 7/16-20



**302 Series**  
90° Female Pipe Elbow - NPT

Part Number	NPT Thread
3020404CLF	¼
3020606CLF	⅜
3020808CLF	½
3021212CLF	¾



**304 Series**  
90° Street Elbow - NPT

Part Number	NPT Thread
3040202CLF	⅛ x ⅛
3040404CLF	¼ x ¼
3040606CLF	⅜ x ⅜
3040808CLF	½ x ½



**322 Series**  
Female Pipe Tee - NPT

Part Number	NPT Thread
3220202CLF	1/8
3220404CLF	1/4
3220606CLF	3/8
3220808CLF	1/2
3221212CLF	3/4

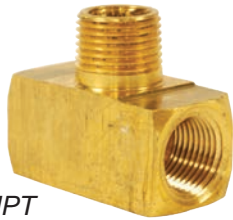

**324 Series**  
Male Branch Tee - NPT

Part Number	NPT Thread
3240606CLF	3/8



**326 Series**  
Street Tee - NPT

Part Number	NPT Thread
3260404CLF	1/4

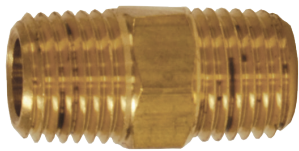

**370 Series**  
Male Hex Nipple - NPT

Part Number	NPT Thread
3700202CLF	1/8 x 1/8
3700404CLF	1/4 x 1/4
3700606CLF	3/8 x 3/8
3700808CLF	1/2 x 1/2



**371 Series**  
Female Hex Coupling - NPT

Part Number	Female NPT
3710202CLF	1/8 x 1/8
3710404CLF	1/4 x 1/4
3710606CLF	3/8 x 3/8
3710808CLF	1/2 x 1/2

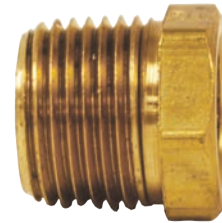

**373 Series**  
Reducer Bushing - NPT

Part Number	Male NPT x Female NPT Thread
3730402CLF	1/4 x 1/8
3730604CLF	3/8 x 1/4
3730804CLF	1/2 x 1/4
3730806CLF	1/2 x 3/8
3731208CLF	3/4 x 1/2

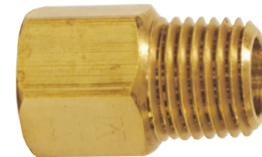

**375 Series**  
Adapter - NPT

Part Number	Female NPT x Male NPT
3750402CLF	1/4 x 1/8
3750404CLF	1/4 x 1/4
3750604CLF	3/8 x 1/4
3750808CLF	1/2 x 1/2
3751212CLF	3/4 x 3/4



**377 Series**  
Reducer Coupler - NPT

Part Number	Female NPT x Female NPT
3770806CLF	1/2 x 3/8
3771208CLF	3/4 x 1/2



**502 Series**

*Female Hose x Female Pipe NPT Swivel*

Part Number	GH Thread x NPT Thread
<b>5021208CLF</b>	$\frac{3}{4}$ x $\frac{1}{2}$
<b>5021212CLF</b>	$\frac{3}{4}$ x $\frac{3}{4}$



**509 Series**

*Male Hose x Male Hose x Female Pipe*

Part Number	Male GH x Male GH x Female NPT
<b>5091212CLF</b>	$\frac{3}{4}$ x $\frac{3}{4}$ x $\frac{1}{2}$



**506 Series**

*Female Hose x Female Hose Swivel*

Part Number	Female GH x Female GH
<b>5061212CLF</b>	$\frac{3}{4}$ x $\frac{3}{4}$



**514 Series**

*Male Hose x Male Pipe x Female Pipe*

Part Number	Male GH x Male NPT x Female NPT
<b>5141212CLF</b>	$\frac{3}{4}$ x $\frac{3}{4}$ x $\frac{1}{2}$



**507 Series**

*Male Hose x Female Pipe Adapter*

Part Number	Male GH x Female NPT
<b>5071212CLF</b>	$\frac{3}{4}$ x $\frac{3}{4}$



**590 Series**

*Male Garden Hose*

Part Number	Hose ID x Male GH
<b>5900812CLF</b>	$\frac{1}{2}$ x $\frac{3}{4}$
<b>5901012CLF</b>	$\frac{5}{8}$ x $\frac{3}{4}$
<b>5901212CLF</b>	$\frac{3}{4}$ x $\frac{3}{4}$



**508 Series**

*Male Hose x Male Pipe Adapter*

Part Number	Male GH x Male NPT
<b>5081208CLF</b>	$\frac{3}{4}$ x $\frac{1}{2}$



**591 Series**

*Female Garden Hose Swivel Fitting*

Part Number	Hose ID x Female GH
<b>5910812CLF</b>	$\frac{1}{2}$ x $\frac{3}{4}$
<b>5911012CLF</b>	$\frac{5}{8}$ x $\frac{3}{4}$
<b>5911212CLF</b>	$\frac{3}{4}$ x $\frac{3}{4}$



# Lead Free

## What is the new lead-free requirement?

In 2011, the Reduction of Lead in Drinking Water Act was signed into law. The Act has reduced the lead content allowed in drinking water systems and plumbing materials by changing the definition of "Lead-Free" in Section 1417 of the Safe Drinking Water Act (SDWA). The new law went into effect January 4th 2014.

## Definition of "Lead-Free"

The term "lead-free" has been updated from not more than 8% lead content to mean "not more than a weighted average of 0.25% lead when used with respect to wetted surfaces of pipes, pipe fittings, plumbing fittings and fixtures."

## Lead Free Exemptions

The new requirement does not apply to pipes, pipe fittings, plumbing fittings, or fixtures, including back flow preventers, that are used exclusively for non-potable services, such as manufacturing, industrial processing, irrigation, outdoor watering, or any other uses where the water is not anticipated to be used for human consumption.

## Dixon Brass Standard Brass Parts

Our brass parts are machined from Brass Alloy CDA 353, 360 or 377. The lead content is 2.5% to 3.7%. Our brass shape products are produced from Alloy C3604B with a lead content of 1.8% - 3.7%. These brass alloys do not meet the low lead requirements as stated in the Safe Drinking Water Act. Dixon Brass parts are within the acceptable level for leaded brass rod for the RoHS Directive 2001/65/EU. The exemption is Annex 6(C) for copper alloy containing up to 4% lead by weight. Dixon Brass parts are also Mercury free.

## The "LF" option in the catalog

We are offering select products with a "lead free" option. These will be denoted with an "LF" behind the standard part number. The "LF" option products will be functionally the same as our brass option, but the design and dimensions may be modified. All parts with the "LF" option will have  $\leq 0.25\%$  lead and will meet the definition of "lead free" in Section 1417 of the Safe Water Drinking Act. Please contact Dixon if you require additional "lead free" products beyond those listed in our catalog.



## Size Comparisons

### Actual Outside Diameters of Pipe Threads

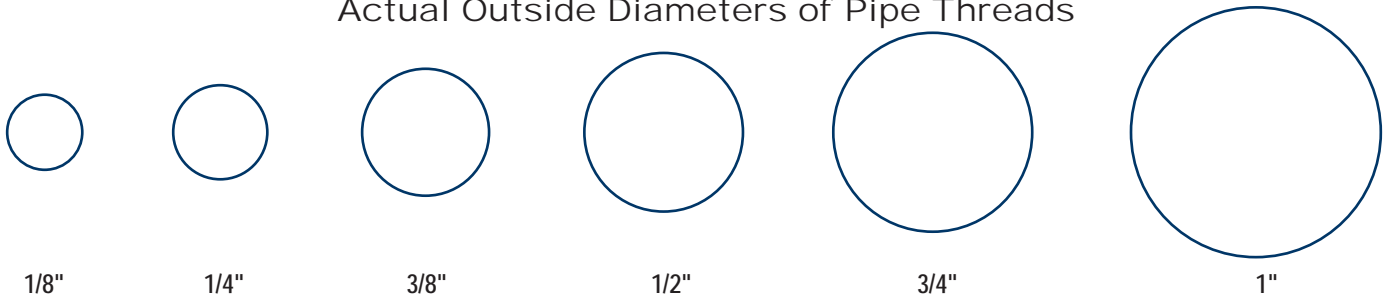

### Actual Outside Diameters of Tubing

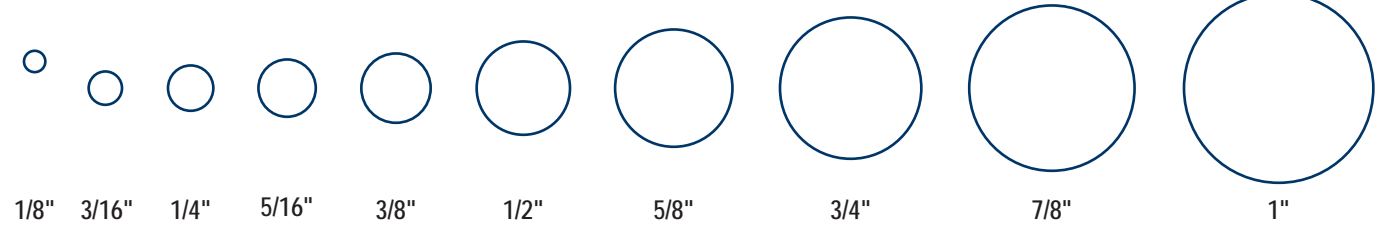

### Male Thread Profiles



## Threading Information

Abbreviation	System Name	Compatibility	Seal Method
<b>BSPP</b>	<b>British Standard Pipe Parallel</b>	male BSPP with female BSPP	washer
		female BSPP with male BSPP	washer
		female BSPP with male BSPT	washer
<b>BSPT<sub>r</sub></b>	<b>British Standard Pipe Taper</b>	male BSPT <sub>r</sub> with female BSPT <sub>r</sub>	thread
		male BSPT <sub>r</sub> with female BSPP	washer
		female BSPT <sub>r</sub> with male BSPT <sub>r</sub> <i>female BSPT<sub>r</sub> not compatible with male BSPP</i>	thread
<b>CHT</b>	American Standard Fire Hose Thread (1" National Hose Thread is <b>Chemical Hose Thread</b> , also known as <b>Booster Hose Thread</b> )	1" male NH (NST) with 1" female NH (NST)	washer
		1" female NH (NST) with 1" male NH (NST)	washer
		1" thread is used on both ¾" hose & 1" hose	not compatible
<b>GHT</b>	<b>Garden Hose Thread</b>	male GHT with female GHT	washer
		female GHT with male GHT	washer
		thread is same for all size hose	not compatible
<b>IPS</b>	<b>Iron Pipe Straight Thread</b>	generic name for Straight Pipe Thread <i>see NPSH for compatibility</i>	washer
<b>IPT</b>	<b>Iron Pipe Thread</b>	generic name for All Pipe Thread	more information required
<b>JIC</b>	<b>Joint Industrial Committee</b>	used with other mating JIC threads	mechanical
<b>NH or NST</b>	American Standard Fire Hose Coupling Thread ( <b>National Hose</b> thread also known as <b>National Standard Thread</b> )	male NH (NST) with female NH (NST)	washer
		female NH (NST) with male NH (NST) thread pitch and diameters of fire threads may vary according to local and municipal regulations <i>not compatible with other systems</i>	washer
<b>NPT</b>	American Standard Taper Pipe Thread ( <b>National Pipe Tapered</b> )	male NPT with female NPT	thread
		male NPT with female NPTF	thread
		male NPT with female NPSM	washer
		male NPT with female NPSH	washer
		female NPT with male NPT	thread
		female NPT with male NPTF <i>female NPT not compatible with male NPSM or male NPSH</i>	thread
<b>NPTF</b>	American Standard Taper Pipe Fuel Dryseal Thread ( <b>National Pipe Tapered Dryseal</b> )	male NPTF with female NPTF	thread
		male NPTF with female NPT	thread
		male NPTF with female NPSM	washer
		male NPTF with female NPSH	washer
		female NPTF with male NPTF	thread
		female NPTF with male NPT	thread
		female NPTF with male NPSM or NPSH <i>NPTF with NPTF threads do not require sealant for the initial use, after that, sealant is required</i>	not compatible
<b>NPSH</b>	American Standard Straight Pipe for Hose Couplings ( <b>National Pipe Straight Hose</b> )	male NPSH with female NPSH	washer
		female NPSH with male NPSH	washer
		female NPSH with male NPT	washer
		female NPSH with male NPTF	washer
		female NPSH with male NPSM	washer
<b>NPSM</b>	American Standard Straight Mechanical Joints ( <b>National Pipe Straight Mechanical</b> )	male NPSM with female NPSM	Seal can be either mechanical or washer. Mating fittings must be of same type.
		male NPSM with female NPSH	
		female NPSM with male NPSM	
		female NPSM with male NPT	
		female NPSM with male NPTF	
<b>SIPT</b>	<b>Straight Iron Pipe Thread</b>	generic name for Straight Pipe Thread	washer
<b>TIPT</b>	<b>Tapered Iron Pipe Thread</b>	generic name for Tapered Pipe Thread	thread
<b>NYC</b>	<b>NYC Fire Department</b>	straight thread used in New York City	washer
<b>Chicago</b>	<b>Chicago Fire Department</b>	straight thread used in Chicago	washer

---

## Limited Warranty

DIXON VALVE AND COUPLING COMPANY (herein called "Dixon") warrants the products described herein, and manufactured by Dixon to be free from defects in material and workmanship for a period of one (1) year from date of shipment by Dixon under normal use and service. Its sole obligation under this warranty being limited to repairing or replacing, as hereinafter provided, at its option any product found to Dixon's satisfaction to be defective upon examination by it, provided that such product shall be returned for inspection to Dixon's factory within three (3) months after discovery of the defect. The repair or replacement of defective products will be made without charge for parts or labor. This warranty shall not apply to: (a) parts or products not manufactured by Dixon, the warranty of such items being limited to the actual warranty extended to Dixon by its supplier; (b) any product that has been subject to abuse, negligence, accident, or misapplication; (c) any product altered or repaired by others than Dixon; and (d) to normal maintenance services and the replacement of service items (such as washers, gaskets and lubricants) made in connection with such services. To the extent permitted by law, this limited warranty shall extend only to the buyer and any other person reasonably expected to use or consume the goods who is injured in person by any breach of the warranty. No action may be brought against Dixon for an alleged breach of warranty unless such action is instituted within one (1) year from the date the cause of action accrues. This limited warranty shall be construed and enforced to the fullest extent allowable by applicable law.

Other than the obligation of Dixon set forth herein, Dixon disclaims all warranties, express or implied, including but not limited to any implied warranties of merchantability or fitness for a particular purpose, and any other obligation or liability. The foregoing constitutes Dixon's sole obligation with respect to damages, whether direct, incidental or consequential, resulting from the use or performance of the product.

Some products and sizes may be discontinued when stock is depleted, or may require a minimum quantity for ordering.

---

## Limits of Liability

This catalog is intended as a product offering. It is not intended to be a user or technical manual. Information in this catalog is subject to change without notice. All users and distributors of products sold through this catalog should contact Dixon™ with questions of use, compatibilities, coupling procedures and life of product. Our full-time engineering and test staff is always available to recommend uses and to assist distributors and users with any questions.



---

## Safety



Safety logos, which appear throughout our catalog, are used as a reminder that the user should carefully review for the appropriateness of the product for the media, application and environment in which it will be used.

NOTE: Because of the health hazards associated with contamination and lead content in drinking water systems, Dixon™ couplings, unless otherwise specifically approved, are not recommended for potable water service and should not be used in applications where drinking water will contact the wetted surfaces of the coupling.

Warning: Dixon™ products may contain chemicals known to the State of California to cause cancer, birth defects, or other reproduction harm.

---

## Copyright

Copyright © 2016 by Dixon Valve and Coupling

All rights reserved. This book is copyrighted material. Use, reproduction or copying of it by anyone other than Dixon™ is strictly forbidden without its express written consent.

**GOODYEAR**  
GOODYEARBELTING.COM

**Call Toll Free: 1-866-711-4673**  
**International: +1-727-342-5086**

**We Ship**  
**World Wide**

## United States

### Albany, NY

ph 518.725.0998  
178A Corporate Drive  
Gloversville, NY 12078  
fx 518.725.8542

### Atlanta, GA

ph 770.486.9619  
101 T.D.K. Boulevard  
Suite A  
Peachtree City, GA 30269  
fx 770.486.9813

### Dallas, NC

ph 704.376.5755  
2925 Chief Court  
Dallas, NC 28034  
fx 704.376.1557

### Chestertown, MD

ph 800.355.1991  
800 High Street  
Chestertown, MD 21620  
fx 800.283.4966

### Chicago, IL

ph 630.323.3716  
1011 N. Hilltop Drive  
Itasca, IL 60143  
fx 630.323.4120

### Cleveland, OH

ph 330.425.3000  
1900 Enterprise Parkway  
Twinsburg, OH 44087  
fx 330.425.1527

### Houston, TX

ph 713.678.4291  
6525 Homestead Road  
Houston, TX 77028  
fx 713.678.8105

### Kansas City, MO

ph 816.221.0064  
1244 Saline Street  
N. Kansas City, MO 64116  
fx 816.221.1108

### Los Angeles, CA

ph 909.605.6400  
8840 Flower Road  
Suites150/160  
Rancho Cucamonga, CA 91730  
fx 909.605.6200

### Portland, OR

ph 503.289.0400  
2642 North Marine Drive  
Portland, OR 97217  
fx 503.289.0600

### Salt Lake City, UT

ph 801.972.1180  
McGillis Ind. Pk. Bldg., #4  
1972 South 4370 West  
Salt Lake City, UT 84104  
fx 801.972.8063

### Tampa, FL

ph 813.247.3500  
5120 Adamo Drive  
Suite E  
Tampa, FL 33619  
fx 813.247.7910

## International

### Edmonton, Alberta, Canada

ph 780.469.5444  
fx 780.463.9205

### Innisfil, Ontario, Canada

ph 705.436.1125  
fx 705.436.6251

### Montreal, Quebec, Canada

ph 514.422.9292  
fx 514.422.0166

### Wingfield SA, Australia

ph 61.8.8202.6000  
fx 61.8.8202.6099

### Preston, England

ph 44.1.77.232-3529  
fx 44.1.77.231.4664

### Troisdorf-Spich, Germany

ph 49.2241.84406.0  
ph 49.2241.8440679

### Monterrey, Mexico

ph 52.81.8354.5649  
fx 52.81.8354.8197



*The Right Connection®*

### Dixon Brass

40 Chestnut Avenue  
Westmont, IL 60559-1128  
ph 800.323.4440 local 630.323.4442  
fx 800.628.7259 local 630.323.4317  
brasssales@dixonvalve.com

[dixonvalve.com](http://dixonvalve.com)



*customer service*



**GOODYEAR**  
GOODYEARBELTING.COM

**Call Toll Free: 1-866-711-4673**  
**International: +1-727-342-5086**

**We Ship  
World Wide**